

Operating Manual

Uninterruptible Power Supply

**Wärtsilä JOVYTEC PNT
1000VA – 3000VA**



BAX 3313_en

| Index | Date | Name | Revision |
|-------|-----------------|----------------|---|
| 0 | 28. March. 2007 | A.Heller | Original |
| 1 | 14.May 2007 | A.Heller | Revision Compass Distances |
| 2 | 30.05.2007 | Th.Harms | 07/277 |
| 3 | 13.06.2007 | A.Heller | ID added |
| 4 | 15.11.2007 | A.Heller | Designation X1 added |
| 5 | 24.01.2008 | A.Heller | Software Version added |
| 6 | 04.08.2008 | A.Heller | DNV Certificate added |
| 7 | 29.08.2008 | Th. Harms | 08/308 Relay card removed (Not possible at NT Series) |
| 8 | 23.03.2009 | A.Heller | 09/149 Battery Security Data Sheet added |
| 9 | 26.03.2010 | A.Heller | 10/113 Battery Datas added in technical data |
| 10 | 11.07.2011 | A.Heller | BV Certificate added |
| 11 | 16.01.2012 | Chr. Fechteler | 12/024 |
| 12 | 10.07.2012 | Chr. Fechteler | 12/319 |
| 13 | 12.09.2012 | A.Heller | 12/409 |
| 14 | 25.04.2013 | Chr. Fechteler | 13/227 |
| 15 | 20.06.2014 | D. Busboom | 14/375 |
| 16 | 09.10.2014 | D. Busboom | 14/559 |
| 14 | 22.12.2014 | Chr. Fechteler | 14/743 |

NOTES!

Notes concerning this operating manual

Thank you for deciding to purchase the uninterrupted power supply units (UPS) out of the series JOVYTEC PNT. They represent reliable protection for the attached consumers.

Please read through this manual very carefully

This manual contains regulations covering safety, installation and operating methods which will help you guarantee to obtain the full performance and operational readiness which these UPS can offer.

Put this manual in a place of safe keeping

It contains important regulations for safe use of these UPS and for reaching manufacturer services if, for some reason, correct operation of the UPS is in doubt.

Keep or reuse the packaging material

The packaging material for these UPS was designed with great care to protect its contents against damage during transport. This material is also useful if you ever have to send the UPS back for checking. Damage which occurs during transport is not covered by the warranty provisions.

Duty to instruct persons

This operating manual is to be read through carefully before assembly and first use of the UPS by persons who will be working with or on the UPS.

This operating manual is an integral part of the UPS. The operator of this device is required to make this operating manual available in an unlimited fashion to every group of persons who transport the UPS, commission it, maintain it or who do any other kind of work on this device.

Validity

This operating manual is in line with state-of-the-art UPS technology at its time of publishing. The contents are not part of the contract but simply serve as a source of information.

Wärtsilä JOVYATLAS EUROATLAS GmbH reserves the right to make any necessary changes to the contents and technology described in this operating manual without having to make an announcement to this effect. We cannot be held responsible for any errors or improper information in this operating manual since there is no duty upon the company to update this operating manual on an ongoing basis.

Loss of warranty

Our deliveries and services rendered are subject to the General Delivery Conditions for Products of the Electrical Industry as well as our General Sales Conditions. We reserve full rights to make any changes to this operating manual, in particular to technical data, operation, dimensions and weights. We request that you make any claims concerning delivered goods within eight days after arrival of the goods together with the packing slip. Complaints made later than this cannot be considered.

Wärtsilä JOVYATLAS EUROATLAS GmbH will annul all duties such as promises to offer a warranty period, service contracts etc. without warning if any spare parts other than original are used for maintenance and repair purposes.

Handling

This operating manual for the UPS is constructed in such a way that all work required for commissioning, maintenance and repair can be conducted by appropriate skilled personnel.

The Service Hotline

There is further information available under Chapter 8 "Service information" for questions about the UPS unit, about the operating manual, service etc.

Copyright

Any passing on, duplication and/or transfer by means of electronic or mechanical means, also extracts thereof, of this operating manual, requires express prior written permission from **Wärtsilä JOVYATLAS EUROATLAS GmbH**.

Copyright **Wärtsilä JOVYATLAS EUROATLAS GmbH**. All rights reserved.

TABLE OF CONTENT

| | | |
|-------|--|----|
| 1. | GENERAL NOTES | 6 |
| 1.1 | SCOPE OF DELIVERY | 6 |
| 1.2 | GENERAL NOTES REGARDING THE UPS DEVICES | 7 |
| 2. | DESCRIPTION OF THE SYSTEM | 7 |
| 3. | GENERAL DESCRIPTION OF THE FUNCTION | 8 |
| 4. | TECHNICAL DATA | 10 |
| 4.1 | 1000 VA | 10 |
| 4.2 | 1500 VA | 11 |
| 4.3 | 2000 VA | 12 |
| 4.4 | 3000 VA | 13 |
| 4.5 | TECHNICAL DATA BATTERIES | 14 |
| 5. | VIEWS OF THE UPS | 15 |
| 5.1 | FRONT VIEW 1000VA – 1500 VA | 15 |
| 5.2 | REAR VIEW 1000 VA – 1500 VA | 16 |
| 5.3 | FRONT VIEW 2000 VA – 3000 VA | 17 |
| 5.4 | REAR VIEW 2000 VA – 3000 VA | 18 |
| 6. | ELECTRICAL CONNECTION | 18 |
| 6.2 | COMMISSIONING | 20 |
| 6.3 | UPS SHUT-DOWN | 20 |
| 7. | OPERATING AND INDICATING ELEMENTS | 21 |
| 7.1 | FUNCTION OF LED AND FUNCTION KEYS | 21 |
| 7.2 | PARAMETERS | 22 |
| 7.3 | CONFIGURATION | 23 |
| 7.4 | TABLE OF THE ADJUSTABLE PARAMETERS | 23 |
| 7.5 | AUTOMATIC/MANUAL BATTERY TEST | 24 |
| 7.6 | OFFLINE MODE | 24 |
| 7.7 | FREE RUNNING MODE | 24 |
| 7.7.1 | FREE RUNNING ON | 24 |
| 7.7.2 | FREE RUNNING OFF | 25 |
| 7.7.3 | SETTING THE BYPASS TOLERANCE + ACTIVATION/DEACTIVATION OF THE BYPASS | 25 |
| 7.7.4 | FREE RUNNING ON, BYPASS DEACTIVATED | 25 |
| 7.7.5 | FREE RUNNING ON, BYPASS ACTIVATED | 25 |

| | | |
|-------|---------------------------------------|----|
| 7.7.6 | GENERATOR MODE | 26 |
| 7.8 | ERROR MESSAGES AND THEIR REMOVAL | 26 |
| 7.8.1 | OPTICAL AND ACOUSTICAL ERROR MESSAGES | 27 |
| 8. | SERVICE INFORMATION | 28 |
| 9. | REMOTE MONITORING | 28 |
| 9.1 | CONNECTING THE UPS TO THE COMPUTER | 28 |
| 9.2 | ASSIGNMENT OF THE RS232 INTERFACE | 28 |
| 10. | SPECIAL EQUIPMENT | 29 |
| 10.1 | ELECTRONIC STOP FUNCTION | 29 |
| 11. | BATTERY | 30 |
| 11.1 | BATTERY OPERATION | 30 |
| 11.2 | SERVICE LIFE OF BATTERIES | 30 |
| 11.3 | INSTRUCTIONS FOR USING THE BATTERIES | 30 |
| 12. | REPLACING AN INTERNAL UPS BATTERY | 31 |
| 13. | MAINTENANCE | 32 |
| 14. | ANNEX | 32 |

1. General notes

Congratulations on chosen a UPS out of the Wärtsilä JOVYTEC PNT series!

This type of static UPS incorporates the latest findings in power electronics and digital signal processing. The UPS offers the best solution of problems in power supply of computer-systems. These UPS are special build for nautical use on ships. UPS of this series are capable to communicate with different computer operating systems through standardized RS232/RS485-interfaces. The necessary software for remote control of the UPS is available as an option.

These UPS are real online systems, which prevents your loads from mains disturbances like spikes, blackouts and voltage variations. The production of these systems is screened by an effective quality management system.

Therefore it offers a perfect solution for your power supply problems; the reliability of the systems is our major goal since over 60 years of experience in secured power supply and techniques.

The scope of this manual is to describe briefly the parts that constitute the UPS and to guide the installer and the user to the correct installation of the system in the chosen room.

The installer and the user will have to read this manual with care and attention and correctly carry-out the instructions provided, especially those relevant to security according to the country standards in force.

For this UPS systems are **Type Approval certificates by GL, DNV and BV** on our website in the download section available: <http://www.jovyatlas.com/ja/JOVYTEC-P-nt,120-83-2>.

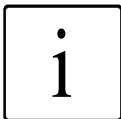

IMPORTANT:

The manufacturer declines all responsibility for damages to people or equipment deriving from non-fulfilment of the above.

1.1 Scope of delivery

The ups – system exists of the following components, which will be delivered:

- UPS – Device
- Mounting Plate with fixing screws and washers
- Communication cable for RS 232 – Interface
- Manual BAX 3313 E
- CD UPSMON (Communication Software)

1.2 General notes regarding the ups devices

NOTE!

The UPS should be attached to the mains supply and switched on at the latest 4 weeks after receipt in order to prevent the battery discharging itself.

PLEASE NOTE!

The batteries used are just designed for the required backup time to supply the nominal load of the UPS. Operation of the UPS unit in free running mode for a longer period of time on battery can damage the batteries. This effect is due to the nature of the battery since for a longer discharge period the final discharging voltage is not reached.

The device may only be opened by trained specialists.

The system is to be connected up and earthed according to VDE regulations. Provisions of the local energy – supply company must be observed.

The ventilation slits on the front and rear sides must not be covered and a distance from the wall of at least **100 mm** is essential.

The UPS unit is built according to Protection Class **IP 21** and is designed for installation in heated internal spaces (at 20°C). A lower operating temperature lowers the bridging time.

No devices with a connecting cable in excess of **10 metres** in length should be connected to the UPS. This measure serves to ensure observance of the EMC standard.

No alterations should be made to the UPS unit. The warranty will expire in cases of inappropriate physical interventions.

PLEASE NOTE!

In order to exclude the possibility of overloading or constant switching over to bypass due to consumer generated non-sinusoidal current peaks, no devices such as laser printers, fax machines as well as devices operating with a similar technology should be connected to the UPS.

In cases where it is essential that such devices be operated then a UPS must be selected whose capacity can match the maximum possible current peaks.

Devices with power reduction due to half wave power consumption, (e.g. coffee machines, hair dryers) can lead to immediate destruction of the power-output stage. The battery is not galvanically isolated from the mains so occurrence of a mains voltage at the battery terminals is possible! The UPS unit does not have an output transformer and is therefore not galvanically isolated from the mains!!

2. Description of the System

UPS devices of this type are particularly suited for supplying critical power consumers in industry and the office such as personal computer, computer-controlled devices, PLCs and similar equipment. The output voltage is sinusoidal. In normal cases the attached consumers are supplied with power from the installed rectifier and installed inverter from the mains power supply network (online operation). Any disturbances in the mains such as voltage peaks, voltage drops, harmonic distortions or noises etc. are filtered out. The installed battery is constantly being charged up by means of a charging rectifier with a charge preservation charging stage which is gentle on the batteries.

3. General description of the function

Normal operation

During normal operation the battery and the inverter are supplied with power via a rectifier (online operation). The change-over from alternating voltage to direct voltage and back to alternating voltage again is achieved by a sinusoid output voltage with a low distortion factor. The direct voltage is also needed for charging the battery. The inverter supplies the attached consumers.

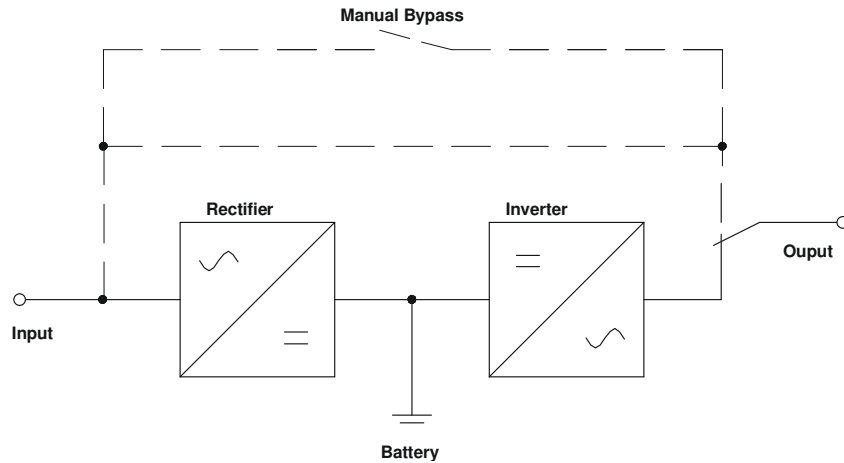

Figure 1: Block diagram "Normal operation"

Power failure

In the case of a power failure, the energy needed by the inverter is taken from the battery. At the output the voltage from the inverter is still available.

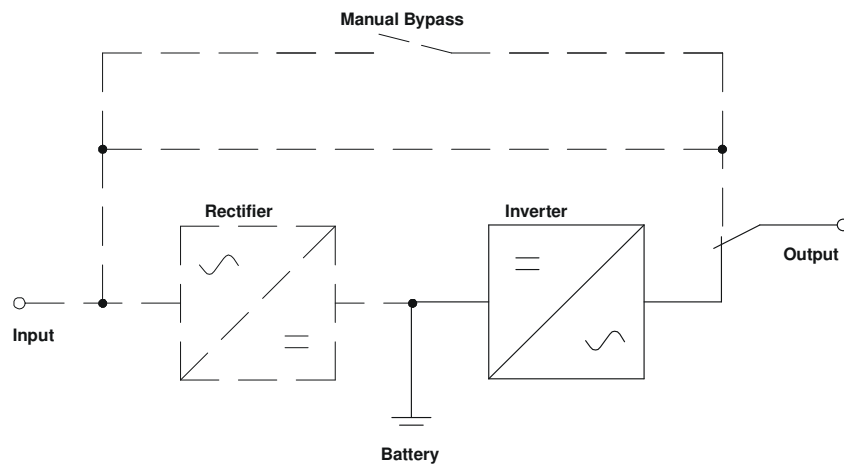

Figure 2: Block diagram "Power failure"

PLEASE NOTE!

The output of the UPS unit also carries a voltage in the case of a power failure!
This is why the installation engineer must mark the outputs and power sockets on the UPS unit clearly according to EN 62040.

Fault in the inverter or an overload (bypass operation)

In the case of a fault occurring in the inverter or an overload, a switch-over device switches the load back to the mains. This means that, in the case of a power failure, the connected consumers will no longer be supplied with power.

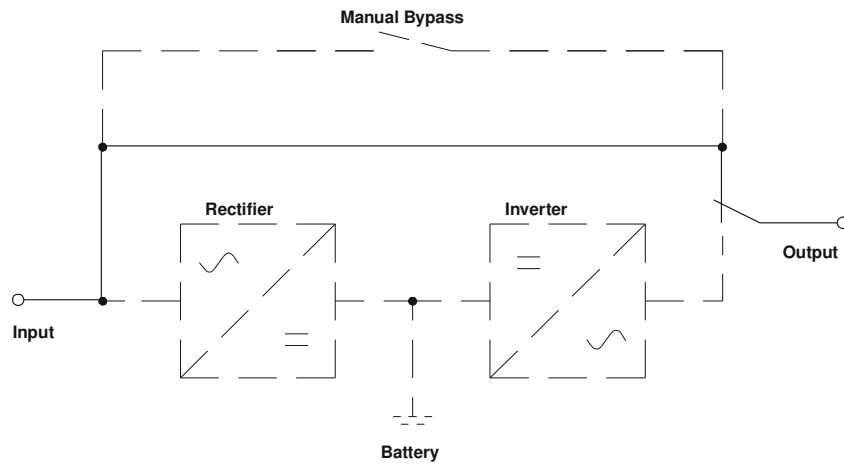

Figure 3: Block diagram "Fault in the inverter"

Manual bypass (service bypass)

If there is a fault in the UPS unit and service work must be undertaken, the UPS unit is fitted with an internal bypass for that purpose. When actuating the manual bypass, the load is directly supplied from the mains. This means that, in the case of a power failure, the connected consumers will no longer be supplied with power. When using the manual bypass it is essential to observe the chapter "UPS internal manual bypass". Other procedures could lead to destruction of the UPS unit or crashing of the power consumer loads.

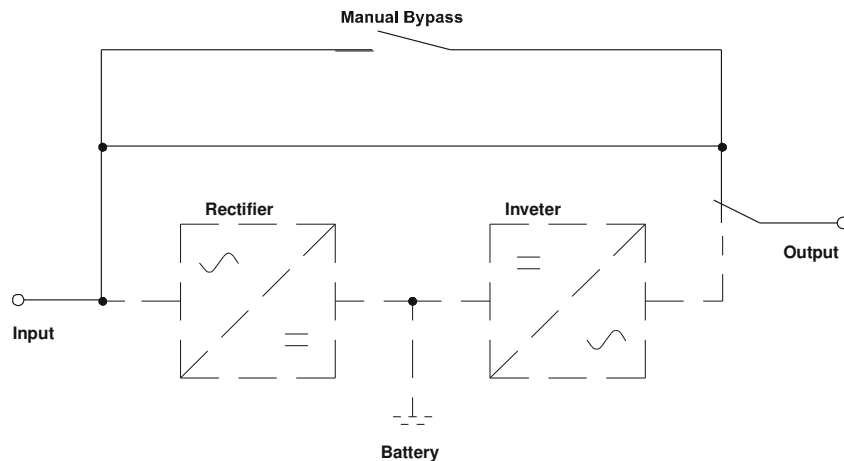

Figure 4: Block diagram "Manual bypass"

PLEASE NOTE!

An operating fault can lead to total loss of power supply to the attached power consumer loads! A power failure for a switched in manual bypass will lead to crashing of the power consumer loads!

4. Technical data

4.1 1000 VA

| | | |
|---|---|---|
| Output power | cos φ 0,7 ind. | 1000VA / 700W |
| Network supply | Voltage | 230V Input voltage ranges 168V - 276V (0-100% load) 140 - 159V (0-70% load) 120 - 139V (0-40% load) |
| | Current with standard charger | 3.6A |
| | Current with additional charger | 4.6A |
| | Frequency | 50Hz \pm 3Hz or 60Hz \pm 3Hz |
| | Phase | Single phase |
| | Power Factor | 0,98 |
| | External fuse protection | D01/10A |
| Battery (installed in battery pack inside the ups) | Direct current link voltage | 36V |
| | Backup time | 8min. at 100% load 13min. at 80% load 24min. at 50% load |
| | Type | Maintenance free, closed lead acid batteries |
| | Charging time | < 8 hours for 90% recharge |
| Output | Voltage | 230V Standard (208V / 220V / 240V selectable at the panel) |
| | Frequency | Automatic adjustment via of the ups |
| | Power factor | cos φ 0,7 ind. |
| | Phase | Single phase |
| | Distorsion factor | < 3% at linear load |
| | Overload behaviour | 100 to 125% for 60 seconds 125 - 150% for 10s |
| | Crest Factor | 3 : 1 |
| Efficiency | AC to AC | 88 - 98% according to the operation mode |
| Switch over behaviour | Power failure | 0ms |
| | Overload switching | Automatic overload switching by the ups |
| Noise level | At an distance of 1m | < 45dB(A) |
| Compass Distances | | Standard 600mm Reserve 450mm |
| Environment | Protection Degree | IP 21 |
| | Temperature | 0°C to 45°C +15 ... +25°C (recommended) |
| | Air humidity | 0% to 95%, non condensing |
| Storage at ... | | 20°C (recommended) with Battery -20°C to 50°C without Battery |
| Applied Rules | | Operation Mode VFI SS 111 acc. t IEC 62040-3, DIN EN 60945 Approved according to IACS Typetest Specification E10 of Det Norske Veritas and Type approved according to the Rules of Germanischer Lloyd and Det Norske Veritas Type approved by Bureau Veritas |
| Interfaces | RS 232-Interface | Supports power management and diagnosis such as BATTERY LOW, UPS ON/OFF Software is compatible with operating systems such as: Windows 95/98/NT/2000/XP, Novell, Unix, etc current operating systems. |
| | Optional: USB Interface Relay card AS/400 - Adapter SNMP - Adapter | |
| Dimensions UPS Device | Width | 152mm |
| | Depth | 425mm |
| | Heights | 238mm |
| Weight UPS | | approx. 9.4 kg |
| Weight UPS incl. Battery | | approx. 17,4 kg |
| Scope of delivery | Hardware/Software | UPS unit Manual BAX 3313E Interface cable, Mounting plate with fixing screws Software UPSMON |

4.2 1500 VA

| | | | | |
|---|---|--|-------------------|--------------------|
| Output power | | cos ϕ 0,7 ind. | 1500VA / 1050W | |
| Network supply | Voltage | 230V Input voltage ranges 168V - 276V (0-100% load) 140 - 159V (0-70% load) 120 - 139V (0-40% load) | | |
| | Current with standard charger | 5,7A | | |
| | Current with additional charger | 6,9A | | |
| | Frequency | 50Hz \pm 3Hz or 60Hz \pm 3Hz | | |
| | Phase | Single phase | | |
| | Power Factor | 0,98 | | |
| | External fuse protection | D01/10A | | |
| Battery (installed in battery pack inside the ups) | Direct current link voltage | 36V | | |
| | Backup time | 6min. at 100% load | 8min. at 80% load | 14min. at 50% load |
| | Type | Maintenance free, closed lead acid batteries | | |
| | Charging time | < 8 hours for 90% recharge | | |
| Output | Voltage | 230V Standard (208V / 220V / 240V selectable at the panel) | | |
| | Frequency | Automatic adjustment via of the ups | | |
| | Power factor | cos ϕ 0,7 ind. | | |
| | Phase | Single phase | | |
| | Distorsion factor | < 3% at linear load | | |
| | Overload behaviour | 100 to 125% for 60 seconds 125 - 150% for 10s | | |
| | Crest Factor | 3 : 1 | | |
| Efficiency | AC to AC | 88 - 98% according to the operation mode | | |
| Switch over behaviour | Power failure | 0ms | | |
| | Overload switching | Automatic overload switching by the ups | | |
| Noise level | At an distance of 1m | < 50dB(A) | | |
| Compass Distances | | Standard 600mm | Reserve 400mm | |
| Environment | Protection Degree | IP 21 | | |
| | Temperature | 0°C to 45°C +15 ... +25°C (recommended) | | |
| | Air humidity | 0% to 95%, non condensing | | |
| Storage at ... | | 20°C (recommended) with Battery -20°C to 50°C without Battery | | |
| Applied Rules | | Operation Mode VFI SS 111 acc. t IEC 62040-3, DIN EN 60945 Approved according to IACS Typetest Specification E10 of Det Norske Veritas and type approved of Det Norske Veritas Type approved by Bureau Veritas | | |
| Interfaces | RS 232-Interface | Supports power management and diagnosis such as BATTERY LOW, UPS ON/OFF | | |
| | Optional: USB Interface Relay card AS/400 - Adapter SNMP - Adapter | Software is compatible with operating systems such as: Windows 95/98/NT/2000/XP, Novell, Unix, etc current operating systems. | | |
| Dimensions UPS Device | Width | 152mm | | |
| | Depth | 420mm | | |
| | Heights | 238mm | | |
| Weight UPS | | approx. 10,4 kg | | |
| Weight UPS incl. Battery | | approx. 18,5 kg | | |
| Scope of delivery | Hardware/Software | UPS unit Manual BAX 3313E Interface cable, Mounting plate with fixing screws Software UPSMON | | |

4.3 2000 VA

| | | | | |
|---|---|--|-----------------------|--------------------------|
| Output power | | cos ϕ 0,7 ind. | 2000VA / 1400W | |
| Network supply | Voltage | 230V Input voltage ranges 168V - 276V (0-100% load) 140 - 159V (0-70% load) 120 - 139V (0-40% load) | | |
| | Current with standard charger | 7,7A | | |
| | Current with additional charger | 8,9A | | |
| | Frequency | 50Hz \pm 3Hz or 60Hz \pm 3Hz | | |
| | Phase | Single phase | | |
| | Power Factor | 0,98 | | |
| | External fuse protection | D01/10A | | |
| Battery (installed in battery pack inside the ups) | Direct current link voltage | 72V | | |
| | Backup time | 8min. at 100% load | 13min. at 80% load | 24min. at 50% load |
| | Type | Maintenance free, closed lead acid batteries | | |
| | Charging time | < 8 hours for 90% recharge | | |
| Output | Voltage | 230V Standard (208V / 220V / 240V selectable at the panel) | | |
| | Frequency | Automatic adjustment via of the ups | | |
| | Power factor | cos ϕ 0,7 ind. | | |
| | Phase | Single phase | | |
| | Distorsion factor | < 3% at linear load | | |
| | Overload behaviour | 100 to 125% for 60 seconds 125 – 150% for 10s | | |
| | Crest Factor | 3 : 1 | | |
| Efficiency | AC to AC | 88 - 98% according to the operation mode | | |
| Switch over behaviour | Power failure | 0ms | | |
| | Overload switching | Automatic overload switching by the ups | | |
| Noise level | At an distance of 1m | < 50dB(A) | | |
| Compass Distances | | Standard 600mm | Reserve 400mm | |
| Environment | Protection Degree | IP 21 | | |
| | Temperature | 0°C to 45°C +15 ... +25°C (recommended) | | |
| | Air humidity | 0% to 95%, non condensing | | |
| Storage at ... | | 20°C (recommended) with Battery -20°C to 50°C without Battery | | |
| Applied Rules | | Operation Mode VFI SS 111 acc. t IEC 62040-3, DIN EN 60945 Approved according to IACS Typetest Specification E10 of Det Norske Veritas and type approved of Det Norske Veritas Type approved by Bureau Veritas | | |
| Interfaces | RS 232-Interface | Supports power management and diagnosis such as BATTERY LOW, UPS ON/OFF | | |
| | Optional: USB Interface Relay card AS/400 - Adapter SNMP - Adapter | Software is compatible with operating systems such as: Windows 95/98/NT/2000/XP, Novell, Unix, etc current operating systems. | | |
| Dimensions UPS Device | Width | 225mm | | |
| | Depth | 425mm | | |
| | Heights | 360mm | | |
| Weight UPS | | approx. 16,2 kg | | |
| Weight UPS incl. Battery | | approx. 32,2 kg | | |
| Scope of delivery | Hardware/Software | UPS unit Manual BAX 3313E Interface cable, Mounting plate and fixing screws with distance washer Software UPSMON | | |

4.4 3000 VA

| | | |
|---|---|--|
| Output power | cos ϕ 0,7 ind. | 3000VA / 2100W |
| Network supply | Voltage | 230V Input voltage ranges 168V - 276V (0-100% load) 140 - 159V (0-70% load) 120 - 139V (0-40% load) |
| | Current with standard charger | 10,7A |
| | Current with additional charger | 11,9A |
| | Frequency | 50Hz \pm 3Hz or 60Hz \pm 3Hz |
| | Phase | Single phase |
| | Power Factor | 0,98 |
| External fuse protection | | D01/16A |
| Battery (installed in battery pack inside the ups) | Direct current link voltage | 72V |
| | Backup time | 6min. at 100% load 8min. at 80% load 14min. at 50% load |
| | Type | Maintenance free, closed lead acid batteries |
| | Charging time | < 8 hours for 90% recharge |
| Output | Voltage | 230V Standard (208V / 220V / 240V selectable at the panel) |
| | Frequency | Automatic adjustment via of the ups |
| | Power factor | cos ϕ 0,7 ind. |
| | Phase | Single phase |
| | Distorsion factor | < 3% at linear load |
| | Overload behaviour | 100 to 125% for 60 seconds 125 – 150% for 10s |
| Crest Factor | 3 : 1 | |
| Efficiency | AC to AC | 88 - 98% according to the operation mode |
| Switch over behaviour | Power failure | 0ms |
| | Overload switching | Automatic overload switching by the ups |
| Noise level | At an distance of 1m | < 50dB(A) |
| Compass Distances | | Standard Reserve |
| Environment | Protection Degree | IP 21 |
| | Temperature | 0°C to 45°C +15 ... +25°C (recommended) |
| | Air humidity | 0% to 95%, non condensing |
| Storage at ... | | 20°C (recommended) with Battery -20°C to 50°C without Battery |
| Applied Rules | | Operation Mode VFI SS 111 acc. to IEC 62040-3, DIN EN 60945 |
| Interfaces | RS 232-Interface | Supports power management and diagnosis such as BATTERY LOW, UPS ON/OFF Software is compatible with operating systems such as: Windows 95/98/NT/2000/XP, Novell, Unix, etc current operating systems. |
| | Optional: USB Interface Relay card AS/400 - Adapter SNMP - Adapter | |
| Dimensions UPS Device | Width | 225mm |
| | Depth | 425mm |
| | Heights | 360mm |
| Weight UPS | | approx. 17 kg |
| Weight UPS incl. Battery | | approx. 33 kg |
| Scope of delivery | Hardware/Software | UPS unit Manual BAX 3313E Interface cable, Mounting plate and fixing screws with distance washer Software UPSMON |

4.5 Technical data batteries

| Battery for 1000VA UPS | | |
|------------------------|------------------------------|-----------------|
| General Data | Voltage | 12V |
| | Capacity | 7Ah |
| | Quantity | 3 pcs. |
| | Weigth each bloc | 2,54kg |
| | Dimensions each bloc (LxWxH) | 151 x 65 x 94mm |
| | Type of battery | JL 205670 |
| Battery for 1500VA UPS | | |
| General Data | Voltage | 12V |
| | Capacity | 7Ah |
| | Quantity | 3 pcs. |
| | Weigth each bloc | 2,54kg |
| | Dimensions each bloc (LxWxH) | 151 x 65 x 94mm |
| | Type of battery | JL 205670 |
| Battery for 2000VA UPS | | |
| General Data | Voltage | 12V |
| | Capacity | 7Ah |
| | Quantity | 6 pcs. |
| | Weigth each bloc | 2,54kg |
| | Dimensions each bloc (LxWxH) | 151 x 65 x 94mm |
| | Type of battery | JL 205670 |
| Battery for 3000VA UPS | | |
| General Data | Voltage | 12V |
| | Capacity | 7Ah |
| | Quantity | 6 pcs. |
| | Weigth each bloc | 2,54kg |
| | Dimensions each bloc (LxWxH) | 151 x 65 x 94mm |
| | Type of battery | JL 205670 |

5. Views of the UPS

5.1 Front view 1000VA – 1500 VA

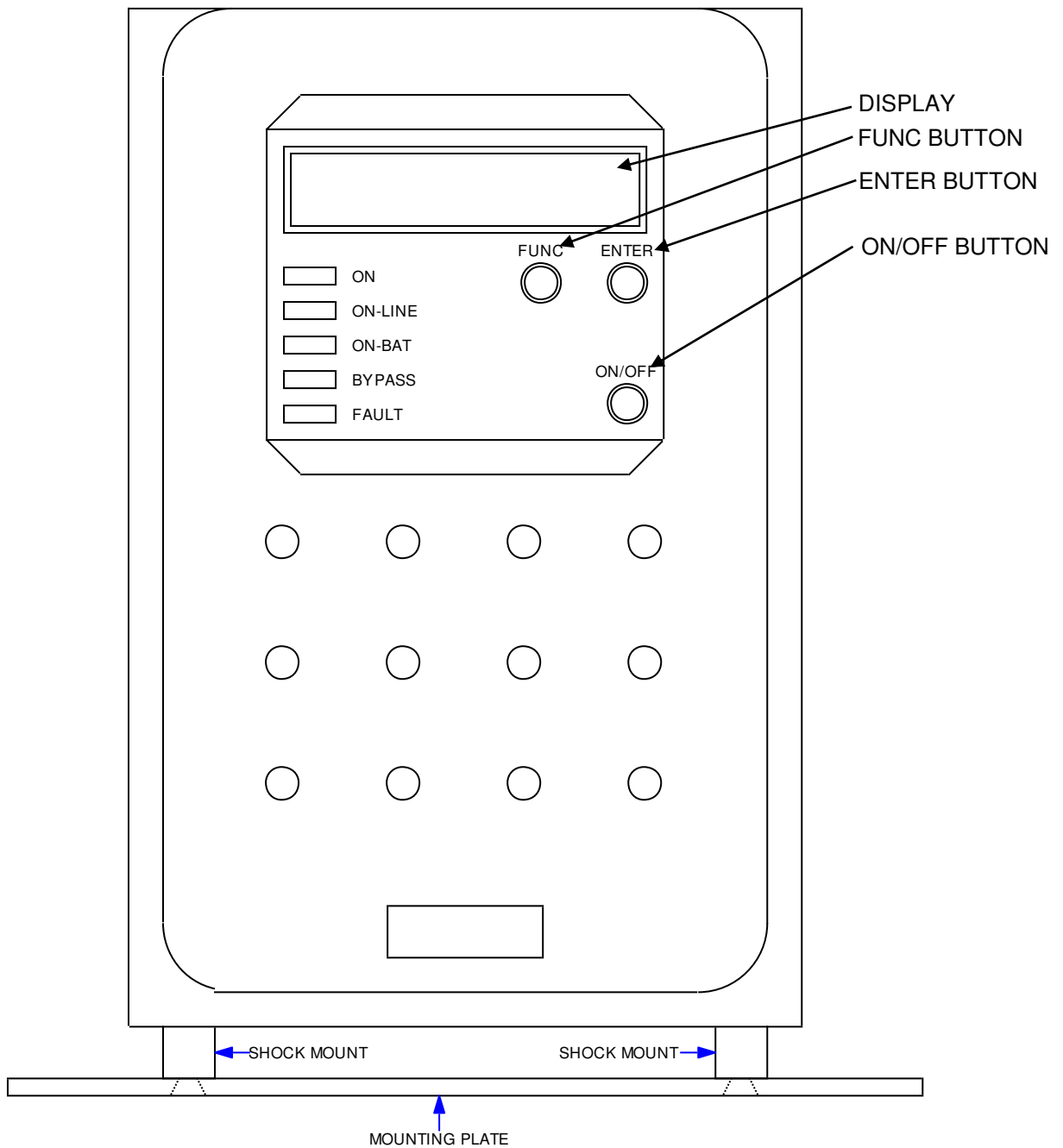

| Sign | Meaning |
|-----------|--------------------------|
| ON | Operation |
| ON - LINE | Output Voltage available |
| ON – BAT | Battery Operation |
| BYPASS | Bypass Operation |
| FAULT | UPS Failure |

Remark for mounting:

JT1000/1500 please use the cross recessed countersunk-head screw M6, and washer.
 JT2000/3000 please use the cross recessed countersunk-head screw M8, and washer

5.2 Rear view 1000 VA – 1500 VA

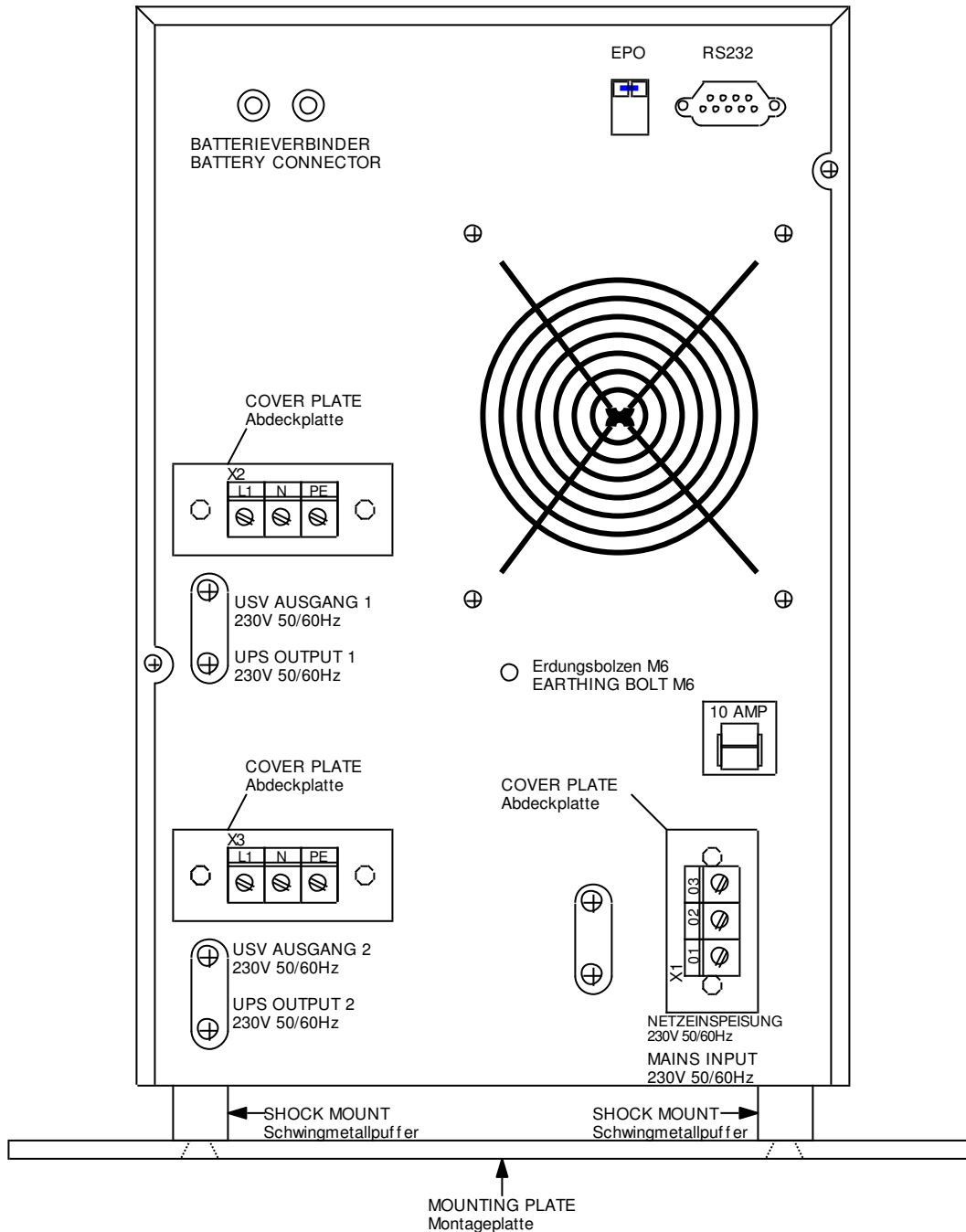

5.3 Front view 2000 VA – 3000 VA

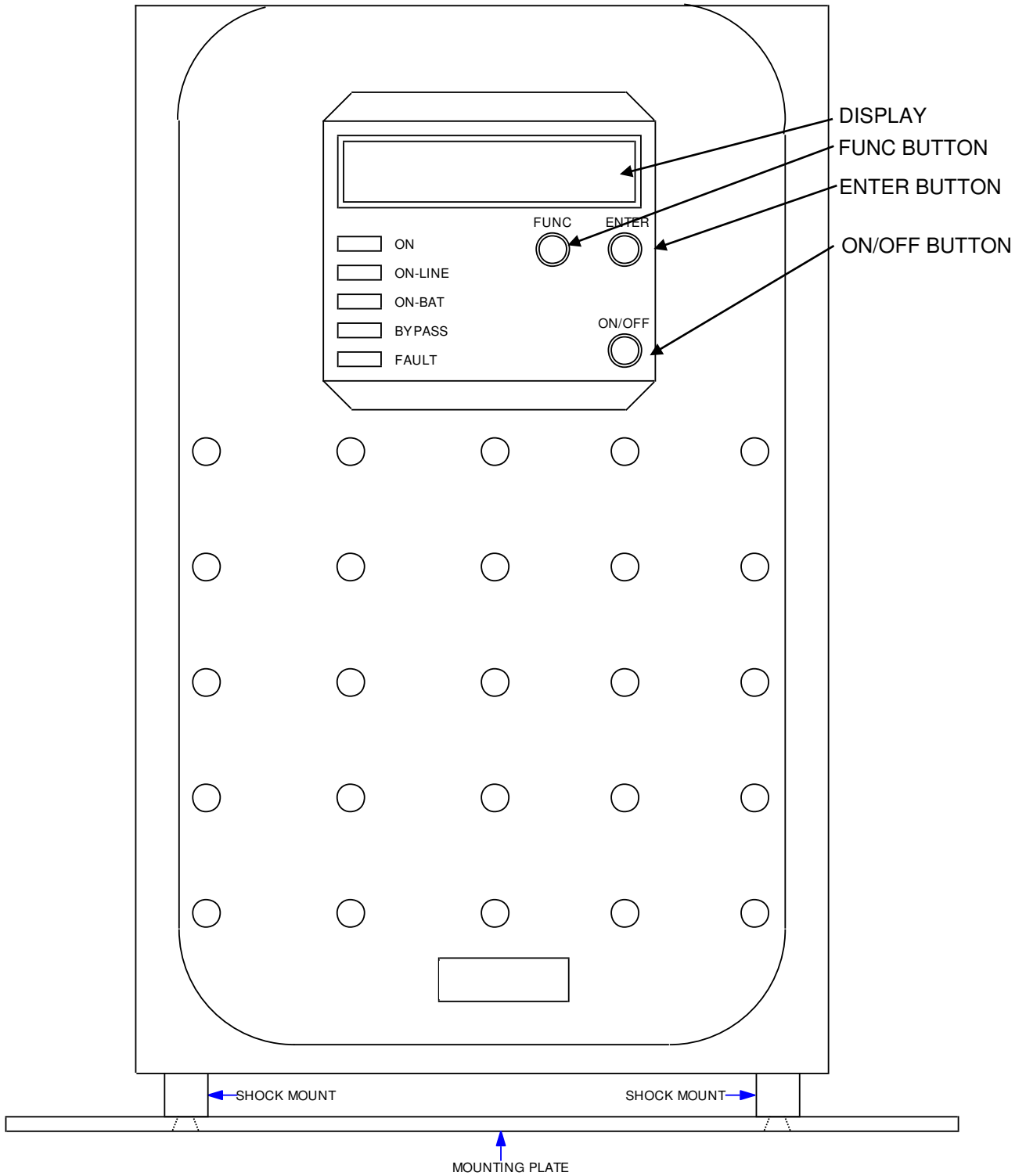

| Sign | Meaning |
|-----------|--------------------------|
| ON | Operation |
| ON - LINE | Output Voltage available |
| ON - BAT | Battery Operation |
| BYPASS | Bypass Operation |
| FAULT | UPS Failure |

5.4 Rear view 2000 VA – 3000 VA

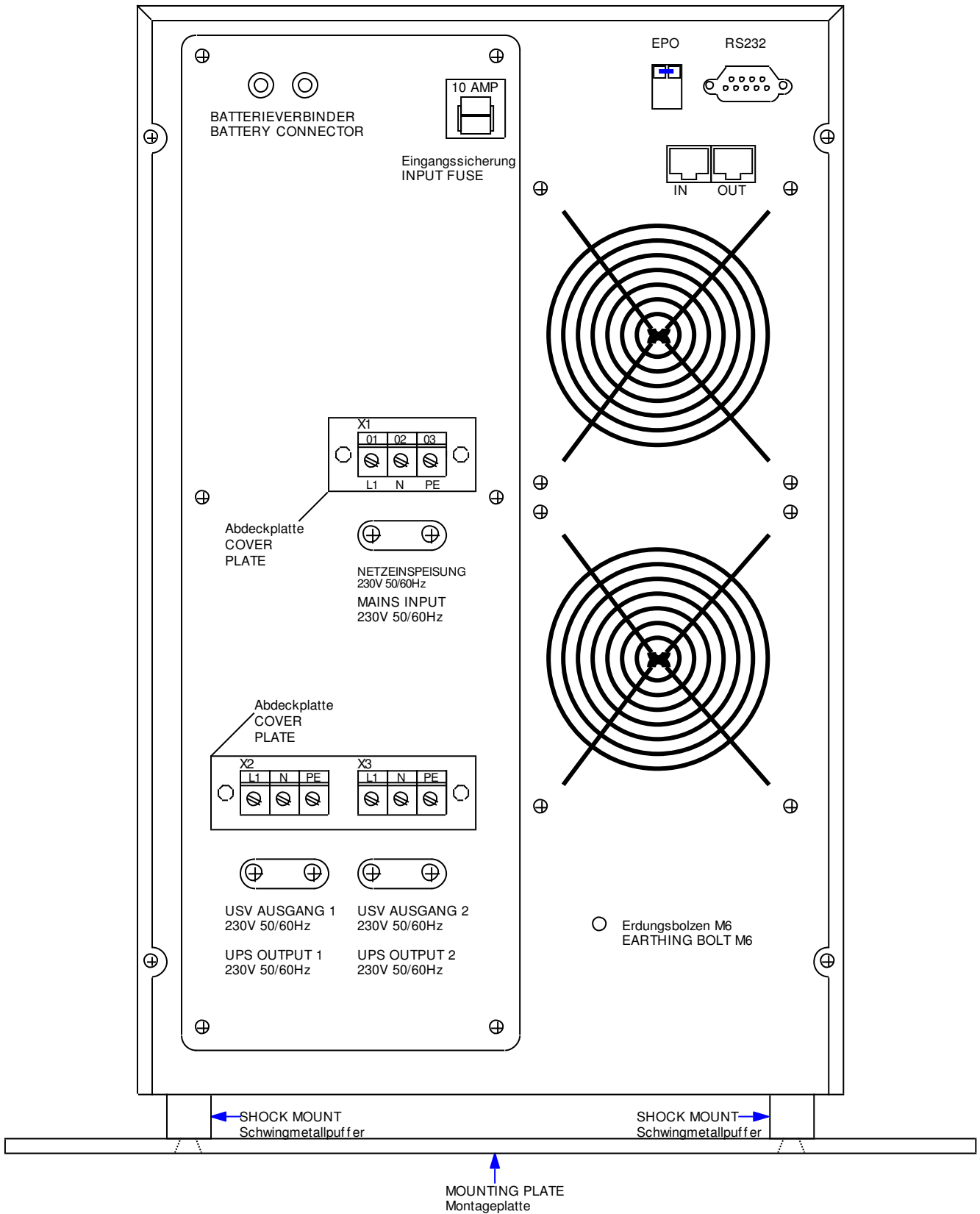

6. Electrical connection

PLEASE NOTE!

Only trained personnel are allowed to work on the UPS unit.

Observe all corresponding safety regulations.

Marking of cables is to be according to DIN EN 60445!

When connecting to the UPS unit, ensure use of an adequately sized protective-conductor connection!

PLEASE NOTE!

When working on the batteries it is possible for dangerous situations to arise due to a high DC voltage and high short-circuit currents.

This work on the device must only be conducted when accompanied by use of suitable protective measures such as insulated tools, eye and hand protection

These UPS units are to be connected by means of the installed terminal board to the mains. Also all load have to be connected via terminal boards, which are installed on the rear side of the ups. The ups – systems are suitable for grounded and isolated mains.

One proceeds as follows:

1. Connect the mains input cable to the terminal rail X1 (L1/N/PE). Fix the connected cable via pull relief on the rear side of the ups.
2. Connect the load cables to the terminal rails X2/X3 (L1/N/PE). Fix the connected cable via pull relief on the rear side of the ups.
3. Set in the battery connector. For transport or shipment of the ups – device this connector has to be removed to prevent short circuit or fire while improper transport.
4. All connecting up work is now complete.

6.2 Commissioning

PLEASE NOTE!

The unit should be started over the input mains. If the input mains is not available for a short time then it is also possible to start the unit over the battery. It is a basic prerequisite for this operating mode that the UPS unit was one time operated over the energy supplier's mains network. Please note that when starting over the external battery, the maximum time the output voltage is available to you is the autonomy time. The UPS unit will also start with the preconfigured parameter, i. e. if the mains previously had 50 Hz then the UPS will generate 50 Hz on the output side.

Take note: The unit fans run as soon as the input voltage is applied!!

The UPS unit can now be started by pressing the **ON/OFF** button in the front panel for 3 seconds; a message appears in the display: **Switching on procedure**. The UPS unit now starts a self-test routine during which its internal functions are tested and the mains synchronisation and the inverter are started. The message "**Battery mode**" is shown in the display during the self-test and the LED's **ON** for UPS ON and **ON-LINE** output voltage light up. The message "**Operation**" appears in the display. The consumers to be supplied can now be switched on.

Please contact us if anything different happens.

6.3 UPS Shut-down

When shutting down the unit please proceed as follows:

- Switch off all consumers
- Press the **ON/OFF** button in the front panel for 3 seconds. An acoustic sound (bleep) is emitted while pressing the **ON/OFF** button and the message: **Switching off soon** appears in the display, and then the message "**UPS OFF**". The UPS unit is now shut-down. **Please note:** The device fans continue to run as long as the input voltage is applied.

7. Operating and indicating elements

7.1 Function of LED and function keys

1. Display indicator

The display indicator informs about the operating modes, menu points and parameters.

2. ON/OFF button

The UPS unit can be switched on and off using the **ON/OFF** button. The formalism is as follows:

The UPS unit is switched on by pressing the **ON/OFF** button for about 3 seconds.

The UPS unit is switched off by pressing the **ON/OFF** button for about 3 seconds.

3. ENTER key

The **ENTER** key can be used to query the parameters which have been set for the UPS unit. Pressing the **ENTER** key for 2 seconds on a running UPS unit will automatically cause the first parameter to be displayed for 10 seconds. Pressing the **ENTER** button again allows one to manoeuvre through the parameters. If the next parameter is not selected within 10 seconds then the UPS unit indicates its condition again.

4. FUNC key

The **FUNC** key can be used to set a parameter such as the output voltage etc.

The formalism is as follows:

Press the **FUNC** key on a running UPS unit for 2 seconds to start the menu for the UPS unit parameters. Pressing of the **ENTER** button selects the parameter to be altered. Once the parameter to be altered has been reached, the desired value can be selected by pressing the **FUNC** button. Pressing the **ENTER** button a second time accepts the desired parameter and stores it.

The current function and status of the UPS is displayed by means of 5 LED on the operating panel.

The conditions are as follows:

- | | | |
|-------------------|--------------------------|---|
| 5. ON | Operation | : This LED glows green if the UPS is switched on |
| 6. ON-LINE | Operation | : This LED glows green both in UPS mode and in bypass mode and also signals that there is an voltage at the output. |
| 7. ON-BAT | Battery operation | : This LED glows yellow for battery operation (power failure) |
| 8. BYPASS | BYPASS | : This LED glows yellow if the UPS unit is running in bypass mode |
| 9. FAULT | FAULT | : This LED glows red if there is an internal error in the UPS, and an acoustic signal is emitted. Press any key in the function panel and the alarm will be switched off. The cause of the alarm is shown in the display. |

7.2 Parameters

The table below show an example of an 1kVA – UPS

| Indicator | Function of the indicator |
|----------------------------|--|
| O/P VOLT = 230.0V | Output voltage of the UPS |
| O/P FREQ = 50,0Hz | Output frequency of the UPS |
| I/P VOLT = 230,2V | Input voltage of the UPS |
| I/P FREQ = 50,2Hz | Input frequency of the UPS |
| BAT VOLT = 24V | Battery voltage of the battery pack |
| O/P LOAD% = 80% | Utilisation of the UPS as a percentage |
| O/P W = 700W | Output in Watts |
| O/P VA = 1000VA | Output in VA |
| O/P CURR = 2A | Output current in A |
| BACKUP TIME = 4Min. | Autonomy time for the current loading |
| BAT CHARG = 80% | Battery charge level in percent |
| TEMPERATURE = 28°C | Temperature of the UPS |
| BAT PACK NUM = 2 | Number of battery cabinets used |
| RATING = 1000VA | Nominal value of the UPS in VA |
| CPU VERSION | CPU software GX0B |

7.3 Configuration

Use of the function display and the function keys allows diverse settings to be made on the UPS unit. The formalism is as follows:

- In order to achieve Configuration Mode it is necessary to press the key **FUNC** for 2 seconds. The first configuration parameter appears in the display.
- The key **FUNC** is used to manoeuvre through the parameters.
- The key **ENTER** is used to select the parameter point to be altered.
- The key **FUNC** is used to move through the options for the selected parameter.
- The key **ENTER** is used to confirm the selected option and the display readout: *Save ?* appears before hand
- Saving is achieved by pressing the key **ENTER** again.

PLEASE NOTE!

If the selected option is not stored within 10 seconds then the value is reset automatically and the menu goes back into its normal condition.

7.4 Table of the adjustable parameters

| Adjustable parameter | Indication in the display | Explanation | Selections for parameter | Factory setting |
|---|---------------------------|--|---|---------------------------------------|
| Adjusting the output voltage | O/P V adjustment | Nominal voltage | 208/220/ 230/240V | 230V |
| Setting the input frequency tolerance | I/P Freq. Adjustment | Frequency tolerance in unsynchronised mode | ± 2% ± 5% ± 7% | ± 5% |
| Setting of the tolerance of the bypass voltage | I/P bypass adjustment | Voltage tolerance | ± 10% +10/-15% +15/-20% | +10/-15% |
| Free Run Mode | Free-Run-Set | Unsynchronised mode | ON/OFF | ON |
| Bypass activation/deactivation in Free Run Mode | Free-Run-Mode | If activated the UPS will switch to bypass if the preset parameters are not maintained | ON/OFF | OFF |
| Operating mode setting | HE mode setting | Online/Offline mode | ON/OFF | OFF |
| Setting for a permanent manual bypass | Man. bypass setting | Activate manual bypass (only for servicing)* | ON/OFF | OFF |
| Load management | Load segment setting | Segment 1 ON/OFF Segment 2 ON/OFF | ON/OFF | ON |
| Performing a battery test | Manual battery test | Battery test Battery OK. Battery not OK. | ON/OFF | OFF |
| Quiet functioning | Alarm acoustic | Activate, deactivate the acoustic alarm | ON/OFF | OFF |
| Number of battery cabinets | No. of ext. batteries | Setting number of battery packs for the autonomy calculation; a maximum of 2 | 1 - 2 | Dependent on the required backup time |
| Reversal polarity protection | Phase reversal setting | Activation, deactivation of phase reversal | ON/OFF | OFF |
| Language selection | Language | Language selection | English German French Spanish Italian | German |
| Generator mode | Generator | Generator mode** | ON/OFF | OFF |
| Setting RS 232 interface | COM control command | Setting of RS232 interface | ON/OFF | ON |

*) The manual bypass function should always be switched off since for a switched on manual bypass the load in the case of a power failure cannot be supplied by the UPS.

***) The UPS should be switched off and then switched on again before the generator is switched.

7.5 Automatic/Manual battery test

Automatic battery test

In the interval of one month the UPS unit performs an automatic battery test. The UPS will return to normal operating mode after the battery test has been performed successfully. **It is not necessary to operate any switches to do this!!**

If the battery is faulty, the message **Battery fault** will be shown in the display and a permanent tone will sound. Please replace the battery in this case.

Manual battery test

The UPS unit is capable of conducting a self-test. Pressing the key **FUNC** causes the unit to run with its configurations menu. Manoeuvre to the point: **Manual Battery Test**. Now press the button **ENTER**. The message **TEST?** appears in the display. If you wish to perform a battery test then confirm by pressing the key **ENTER**. The battery test will now be performed by the UPS unit by itself. The UPS unit will then again run by itself in its normal operating mode after the battery test has been performed successfully. **It is not necessary to operate any switches to do this!!**

If the battery is faulty, the message **E07** will be shown in the display and a permanent tone will sound. Please replace the battery.

7.6 OFFLINE mode

The UPS unit can be operated using special settings via the display or with the software supplied in offline mode. This operating mode has the advantage of only using a small amount of energy.

The formalism for setting to OFFLINE mode is as follows:

- The key **FUNC** must be pressed for 2 seconds to enter configuration mode.
The first configuration parameter appears in the display.
- The key **FUNC** can be used to manoeuvre through the parameters.
- Select the parameter point to be altered using the key **ENTER**, in this case: HE mode
- The key **FUNC** is then used to manoeuvre through the options for the selected parameter (ON/OFF).
- You have the option to select between 10% and 15%, which are the thresholds to be monitored, and if the voltage does not meet this criterion then the UPS switches to battery operation.
- The selected option is confirmed using the key **ENTER** and saved by pressing the key again.
- Ensure that the settings were adopted in that the display shows: High Efficiency.
- The UPS unit will start again automatically after restoration of the mains power and starts in the preset mode after a long period of power loss where the end of the autonomy period was reached and the UPS shut down once the final discharge voltage was reached.

7.7 Free running mode

The text below explains the free running mode. The preset input frequency window of the UPS has a range of 45Hz - 65Hz and is referred to in the following as the input frequency range.

The narrow input frequency range has a frequency range of 49Hz - 51Hz. This range can be set via the display and operates in the following ranges:

I/P input frequency low = $50 \times (1-0.02) = 49\text{Hz}$

I/P input frequency high = $50 \times (1+0.02) = 51\text{Hz}$

7.7.1 Free running ON

If the input frequency is 49.3Hz, this value is within the narrow input frequency range. This means that the output frequency is also 49.3Hz (synchronised) and the UPS unit runs in line mode. If the input frequency then drops below 49Hz, for example 48Hz, the input frequency is outside the narrow input frequency range but still within the broader input frequency window. The output frequency will therefore be 50Hz and the UPS unit will remain in line mode. If the input frequency were 43Hz then it would be outside both the narrow and the broader input frequency window. The UPS unit switches to battery operation and supplies the load via the inverter with 50Hz.

7.7.2 Free running OFF

If the input frequency is 49.3Hz, this value is within the narrow input frequency range. This means that the output frequency is also 49.3Hz (synchronised) and the UPS unit remains in line mode. If the input frequency then drops below 49Hz, for example 48Hz, then the input frequency is outside the specified values for the narrow input frequency range and the UPS unit switches to battery operation and supplies the load via the inverter with 50Hz.

7.7.3 Setting the bypass tolerance + activation/deactivation of the bypass

The UPS unit offers the option of activating and deactivating the bypass. There is also the option of setting the bypass network tolerance via the display (see Chapter 7.4).

The functionality of the bypass tolerance is described below.

If the UPS unit has a fault and the bypass is activated but the input voltage does not have the quality to supply the consumers then the following examples can arise:

7.7.4 Free running ON, bypass deactivated

Example: Input voltage for bypass: **210 V** Input frequency for bypass: **52Hz** Output voltage of UPS: **230 V**

The bypass tolerance is set to +15/-20% as the bypass range window (set via the display) so the bypass window has the following values:

Bypass lower limit: $230\text{ V} \times (1-0.2) = 230\text{ V} \times 0.8 = 184\text{ V}$ Bypass upper limit: $230\text{ V} \times (1+0.15) = 230\text{ V} \times 1.15 = 264.5\text{ V}$

A +/-2% tolerance was selected for the input frequency so the narrow input frequency window is as follows:

Input frequency lower limit: $50\text{Hz} \times (1-0.02) = 49\text{Hz}$ Input frequency upper limit: $50\text{Hz} \times (1+0.02) = 51\text{Hz}$

The broader input frequency range covers the range of 45Hz - 65Hz.

The following situation occurs where the UPS unit has a fault. Before the UPS unit switches to bypass the CPU first checks to see whether the input voltage and the input frequency are within the prescribed window.

- The input voltage (bypass) is:
210V and thus suitable for providing power to the load (184 – 264.5V)
- The input frequency (bypass) is:
52Hz and therefore does not fulfil the criterion for the narrow input frequency window.

Result: The UPS unit will not switch to bypass (not activated) since the preset parameter has not been maintained and the bypass is deactivated.

7.7.5 Free running ON, bypass activated

Example: Input voltage for bypass: **210V** Input frequency for bypass: **52Hz** Output voltage UPS: **230V**

The bypass tolerance is set to +15/-20% as the bypass range window (set via the display) so the bypass window has the following values:

Bypass lower limit: $230\text{ V} \times (1-0.2) = 230\text{ V} \times 0.8 = 184\text{ V}$ Bypass upper limit: $230\text{ V} \times (1+0.15) = 230\text{ V} \times 1.15 = 264.5\text{ V}$

A +/-2% tolerance was selected for the input frequency so the narrow input frequency window is as follows:

Input frequency lower limit: $50\text{Hz} \times (1-0.02) = 49\text{Hz}$ Input frequency upper limit: $50\text{Hz} \times (1+0.02) = 51\text{Hz}$

The broader input frequency range covers the range of 45Hz - 65Hz.

The following situation occurs where the UPS unit has a fault. Before the UPS unit switches to bypass the CPU first checks to see whether the input voltage and the input frequency are within the prescribed window.

- The input voltage (bypass) is:
210V and thus suitable for providing power to the load (184 – 264.5V)
- The input frequency (bypass) is:
52Hz and therefore fulfils the criterion for the broader input frequency window.

Result: The UPS unit switches to bypass since the preset parameter has been maintained and the bypass was activated.

Summary:

Free running mode → On, bypass deactivated → A fault occurs → CPU on UPS checks whether the narrow input frequency window ($\pm 2\%$) and voltage window is being maintained → if parameter OK → no switch-over to bypass → since bypass is deactivated

Free running mode → On, bypass activated → A fault occurs → CPU on UPS checks whether the narrow input frequency window ($\pm 2\%$) and voltage window is being maintained → if parameter OK. → Switch-over to bypass → since bypass is activated.

7.7.6 Generator mode

Generator mode (adjustable via the panel) ensures that the UPS unit is not constantly switching over to battery operation, since the output voltage of the generator often demonstrates distortions or interruptions, but remains in online mode and thus a sinusoidal output voltage for the consumers is achieved.

This functionality has a low loading effect on the battery which means that the working life of the battery is maintained.

PLEASE NOTE!

The UPS unit must be started again after change-over to generator mode.

7.8 Error messages and their removal

This trouble-shooting instruction offers simple tips about how faults can be located and removed.

If an error message occurs in the function display then you may well be able to remove the fault yourself using these trouble-shooting instructions.

The UPS emits acoustic error signals for:

- A mains fault; the UPS unit runs in battery mode and the alarm sounds every 5 seconds.
- Battery discharge; unit runs in battery mode and the alarm sounds twice every 5 seconds.
- Internal error in the UPS; the alarm sounds continuously

The acoustic alarm can be silenced by pressing any key.

7.8.1 Optical and acoustical error messages

| Error message in the display | Acoustic alarm | Description of the alarm | Removing the fault |
|--|------------------------|---|--|
| Overload (output overload) | Two beeps per second | The UPS is overloaded. The load needs more power than the UPS can deliver. The UPS is providing power via the bypass. | Reduce the load by switching off unimportant consumers |
| Battery test (battery test) | | UPS performs a battery test | No action necessary. The UPS switches again to normal operation after a successful battery test |
| Overcharging (over-charge) | Continuous tone | The batteries are over-charged. (Battery charge voltage too high) | Contact the service hotline! |
| Battery discharged (low battery) | Two beeps every 5 sec. | The UPS operates in autonomy mode (loss of input mains) and the final discharge voltage has almost been reached. | The UPS is automatically started again when the input mains network is available again! No action is required! |
| Battery operation (on battery) | A bleep every 5 sec. | The UPS operates in autonomy mode (loss of input mains) | Save your data and shut-down your computer in a controlled fashion. |
| Battery charge fault (charger failure) | Continuous tone | Battery charger defective | Contact the service hotline! |
| Over-temperature (over-temperature) | Continuous tone | Temperature within the UPS is too high | Ensure that all fans on the UPS are running and are not blocked or dirty |
| Short circuit on output side (output short) | Continuous tone | Short-circuit on the consumer side | Remove all loads producing a short circuit |
| High output voltage (High output voltage) | Continuous tone | Overvoltage on the consumer side | Contact the service hotline! |
| Bus fault (Bus fault) | Two beeps per second | Excessively high voltage on the DC side | Contact the service hotline! |
| Reverse polarity fault (site wiring fault) | One bleep per second | Voltage detected between N and PE | Deactivate the reverse polarity protection in the menu |
| Mains fault (line abnormal) | One bleep per second | Synchronisation failed | New start |
| Battery fault | 3 x bleep | No battery or a faulty one | Switch off UPS using the ON/OFF button Connect up a battery. |

8. Service information

SERVICE-HOTLINE!

Telefon: 04958 - 9394 - 30 Telefax: 04958 - 9394 - 10

E-Mail: service.iovyatlas.de@wartsila.com Internet: <http://www.iovyatlas.de>

9. Remote monitoring

The UPS unit is fitted as standard with an RS 232 signal output. This signal output is designed as a RS232-interface (SUB-D, 9-pin), and there is optionally the possibility of using an additional USB interface. Concerning these two interfaces there is the limitation that only one or the other, that is the RS232 or the USB interface, can be used at one time. There is also the option of using the additional rack at the rear. This rack can be fitted with two different cards, one with an SNMP adapter, which allows monitoring of the UPS via the network or the internet, or an AS/400 card with voltage-free contacts.

The RS 232 and USB interfaces serve to allow data transmission between a computer and the UPS unit.

The UPS unit can be monitored and checked by a computer through the use of special software. Switching off of the UPS unit in the case of power failure is possible.

9.1 Connecting the UPS to the computer

The communication between the UPS and computer is delivered as a complete package including the communication cable and management software. It is absolutely essential to use the communication cable delivered since it was directly configured for the RS 232 interface. Ensure that your operating system is compatible with the management software. Instructions for the management software will aid you in installing the software properly.

9.2 Assignment of the RS232 interface

The RS 232 interface uses a 9-pin SUB-D connector (jack). Assignment of the SUB-D connector is as described in the table below.

Pin assignment for the RS 232 interface

| PIN | SIGNAL | DIRECTION | FUNCTION |
|-----|--------|-----------|---------------------------|
| 2 | TxD | Output | TxD output |
| 3 | RxD | Input | RxD/inverter out Input |
| 5 | GND | | GND |
| 6 | CTS | Output | AC fault on output |
| 8 | DCD | Output | Discharge battery |
| 9 | RI | Output | +8/-24 VDC |

RS 232 interface
(Rear side of UPS)

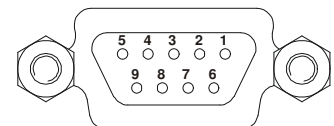

Figure 5: RS232 interface

PLEASE NOTE!
Maximum value 24VDC/50mA!

10. Special equipment

PLEASE NOTE!

The following conversion work or extension to the unit may only be performed by trained personnel and with the UPS unit in a deenergised condition. Observe the relevant safety regulations!!

10.1 Electronic STOP function

The UPS is fitted with an integrated electronic STOP function. This function is deactivated as standard via a bridge at the rear of the UPS unit. If the electronic STOP functionality is to be used then the bridge should be removed on the plug and an external switch (opener) clamped to the rear plug. Actuation of the external electronic STOP switch causes the output of the UPS unit to be switched to voltage-free and the UPS unit shuts down. In order to provide the consumers with a voltage again the electronic STOP switch must be reset and the UPS restarted. There is still a **voltage** inside and at the terminals even after the electronic STOP function was activated.

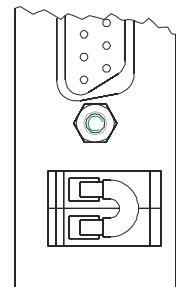

Electronic STOP

11. Battery

11.1 Battery operation

In the case of a network failure the consumers are supplied without interruption from the battery.

In battery operation the LED **ON-BAT (Battery operation)** lights up and an acoustic warning tone sounds every 5 seconds. The acoustic warning tone changes towards the end of the backup time, i. e. when the battery is virtually discharged, to two beeps sounding every 5 seconds. The backup time of a number of minutes generally allows targeted switching off of consumers or data storage/back-up when operating a PC, without losing data or having running processes interrupted in an uncontrolled manner. The backup time can be extended significantly by switching off individual, less important consumers.

Restoration of mains power before total discharge of the battery:

In the case of restoration of the mains power before the end of the backup time, the inverter continues to run automatically until the battery is charged up.

Restoration of mains power after total discharge of the battery:

At the end of the backup time the inverter switches off automatically and the consumers are **no** longer supplied with power.

When the mains power is restored, the consumers begin again to be supplied with power via the inverter. The inverter is switched on again automatically. The battery is charged up again automatically after restoration of the mains power.

11.2 Service life of batteries

Use of closed lead batteries at temperatures above 20°C reduces the expected working life. The table from EUROBAT gives some indication of the approximate working life of the batteries used.

| | Nominal working life of batteries | | |
|-------------|------------------------------------|-------------|-------------|
| | 10 - 12 years | 6 - 9 years | 3 - 5 years |
| Temperature | Expected working life of batteries | | |
| 20°C | 12 years | 9 years | 5 years |
| 30°C | 5 years | 4 years | 2.5 years |
| 40°C | 2.5 years | 2 years | 1.25 years |

11.3 Instructions for using the batteries

12. Replacing an internal UPS battery

UPS units of this series offer the possibility by replacing the battery during operation. One must ensure in this case that the UPS unit is running in normal mode and not in autonomy mode. Proceed as follows to replace the battery:

1. Remove the display panel through the stripping of the plastic cover. For that you seize please under the plastic covering on the front and the hold clip press up. You move at the press up hold clips the covering under gentle pressure forward.
2. Unhook the display panel. The fastening clip is located at the top side of the covering.
3. Remove the fastening screw on the retaining bracket using a Phillips screwdriver. The fastening screw on the retaining bracket is located on the left side of the battery rack.
4. Unhook the retaining bracket.
5. Pull the battery pack out of the UPS unit using the pulling strap. **Please note that if a power failure occurs now the load will not be supplied with power.**
6. Open the battery pack using a Phillips screwdriver by removing the cross-head screws in the upper and downer area of the battery pack.
7. You can now replace the batteries.
8. Screw the battery pack together again using the cross-head screws.
9. Push the battery pack into the battery shaft of the UPS unit.
10. Insert the retaining bracket and secure with the cross-head screw.
11. Hook display panel onto the right side of the UPS unit into the retaining tang.
12. Press on display panel evenly until it engages.
13. Conduct a manual battery test to check the battery. **Please note that when conducting the battery test faulty insertion of the battery could mean that the load is not taken over and this will lead to power consumer crashes.**

13. Maintenance

In case of longer standstill of the UPS (≥ 4 weeks) the battery has to be charged monthly. For this charging you only have to connect the UPS to the mains for a charging time of at least 8 hours. However we recommend a charging time for about 24 hours.

The battery in its standard version is maintenance-free. Please note the hints of the battery-manufacturer in case of using a special battery.

The ventilation slots front- and backsides of the UPS have to be clean, without any dust or something soiling to prevent a reduced air-exchange. Please observe the necessary distance to surrounding walls of at least **100 mm**.

Half a year you have to check up the perfect function of the UPS. Therefore you have to disconnect the UPS from the mains with connected load / consumers.

We recommend the use of a remote control system in case of UPS systems which can't be controlled directly.

The lifetime of the fans is indicated with typical 20.000h. We recommend a punctual replacement.

14. Annex

Dimensional Drawing Mounting Plate M0006003_EZ3.pdf

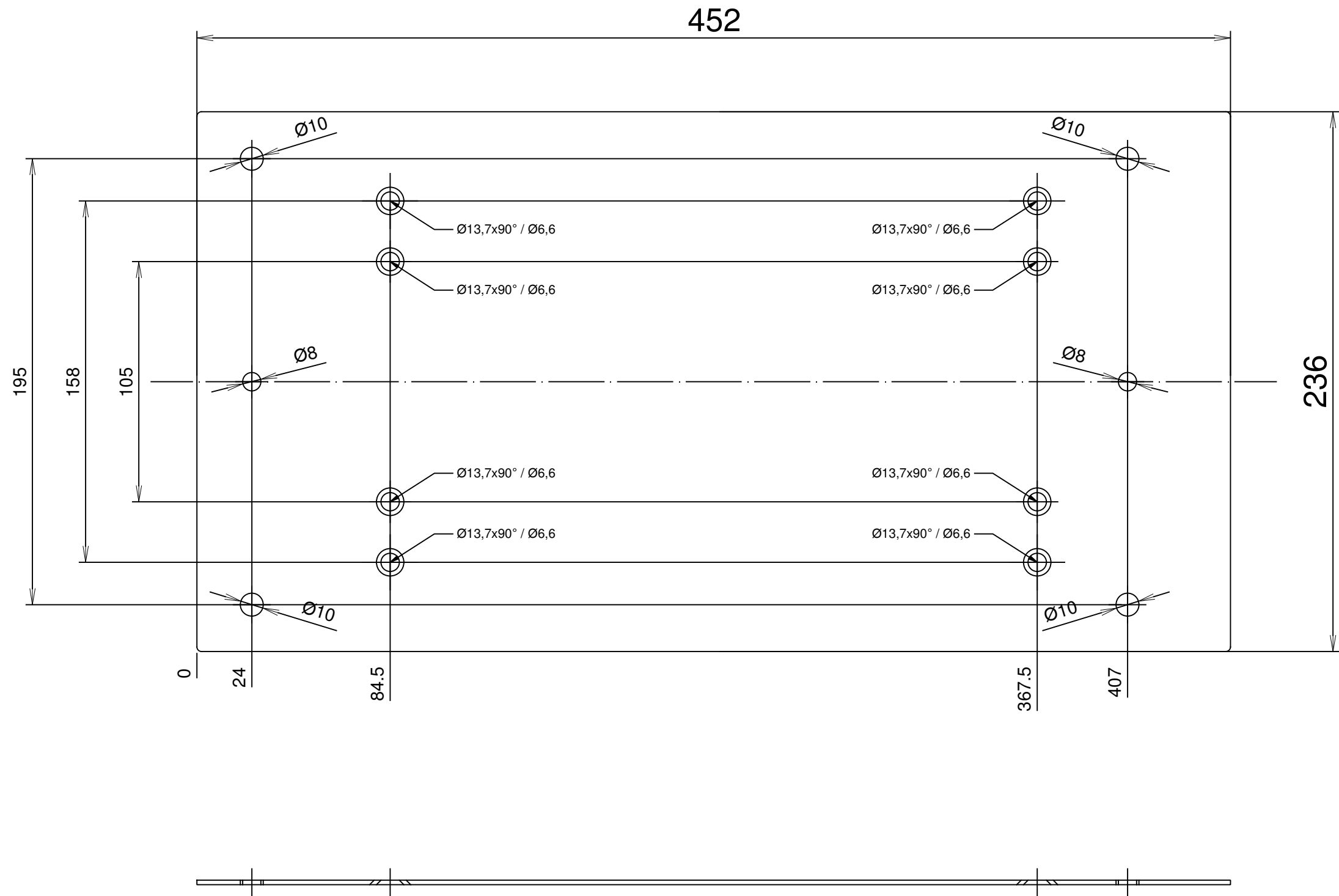

Durch die fehlende Materialdicke des Montageblechs können die Senkungen 4x Am6 DIN 74 und 4x Am8 DIN 74 nicht normgerecht ausgeführt werden. Die Senkungen müssen aber trotzdem so tief eingebracht werden, dass die verwendeten Schrauben komplett in der Senkung liegen und nicht über das Material hinausragen.

| | | | | | | | | | | | | | | | | | | | | | | | | | |
|-----------------------|-----------------|------------|---|--|---------------|--|--|----------------------------|--|--|---|--|---|-----------|--|-------------------|--|--------------------------|--|----------------------------------|-----------------|--|---|-------------|---|
| Datum: Date: | | 31.10.2012 | Allgemeintoleranzen: General tolerances: | | DIN 2768 m | Werkstückbearbeitung: Treatment: | | entgratet DIN ISO 13715 | Allgemeine Bezeichnung: General description: | | Zeichnungs-Nr.: Drawing-no.: | M 00 060 03 . EZ 3 | Benennung: Drawing description: | | Einzelteil - Zeichnung | Detail drawing | | | | | | | | | |
| Name: Name: | | B. Janssen | Werkstoffart: Material: | | n. Angabe | Werkstoffdicke: Material thickness: | | 2,0mm | Montageblech USV-Anlagen JOVYTEC P 1000 / 1500 / 2000 NT Kundenmodifizierung SAM | | Datei-Name: File-name: | M0006003.DWG | Abwicklungs-Datei: Flat projection file: | | ZEICH_MM00060xx\M0006003_VA.DXF (1.4301) ZEICH_MM00060xx\M0006003_VZ.DXF (1203 VER) | | | | | | | | | | |
| 15/553 | Datum: Date: | 19.10.2015 | Name: Name: | | A.Schwarzkopf | Geprüft: Checked: | | O. Böke | Oberflächenbehandlung: Surface treatment: | | n. Angabe | Lackierung: Varnishing: | | n. Angabe | Auftrags-Nr.: Order-no.: | | - | Maßstab: Scale: | | Nicht maßstäblich / Not scalable | | | | | |
| Zustand: Revision: | Datum: Date: | | Name: Name: | | B. Steinbach | Norm: Norm: | | | Werkzeug Kantbank: Tool metal bender: | | V6 V10 V16 | Program-Nr. Kantbank: Prog.-no. metal bender: | | - | Abwicklungsabmessungen: Dimensions of flat projection: | | 452mm x 236mm x 2,0mm (1.4301) 452mm x 236mm x 2,0mm (1203 VER) | Lager-Nr.: Stock-no.: | | 69-1527 | Blatt: Page: | | 1 | von: of: | 1 |

www.jovyatlas.de