

CONTOIL® Control VZF 15...50

Technical data 1)



- display of total volume, resettable volume, and flow rate in m³, litres or US gallons 2)
- user-friendly, interactive parameter input
- fuel oil meter with threaded or flanged connections
- for mounting in horizontal or vertical positions

Versions available on request:

- different flange drillings, such as ANSI, JIS

Type			VZF 15	VZF 20	VZF 25	VZF 40	VZF 50
Nominal diameter	DN	mm	15	20	25	40	50
		inch	1/2	3/4	1	1 1/2	2
Installation length		mm	165	165	190	300	350
Nominal pressure with threaded ends with flanges	PN	bar	16	16	16	16	16
	PN	bar	25	25	25	25	25
Maximum temperature	T _{max}	°C	130, 180				
Maximum flow rate	Q _{max} 3)	l/h	600	1500	3000	9000	30000
Nominal flow rate	Q_n 3)	l/h	400	1000	2000	6000	20000
Minimal flow rate	Q _{min}	l/h	10	30	75	225	750
Approx. starting flow rate		l/h	4	12	30	90	300
Max. permissible error			± 1% of actual value				
Repeatability			± 0.2%				
Safety filter mesh size		mm	0.400	0.400	0.400	0.800	0.800
Dirt filter mesh size		mm	0.250	0.400	0.400	0.600	0.600
Volume of measuring chamber		approx. cm ³	12	36	100	330	1200
Housing finish			enamelled red RAL 3013				
Weight with threaded ends 4)		approx. kg	2.2	2.5	4.2	17.3	–
	with flanges PN 25	approx. kg	3.8	4.5	7.5	20.3	41.0
Smallest readable amount:							
Total volume		l	No decimal places				
Resettable volume		l	1 decimal place				
Digital flow rate display		l/h	1 decimal place				
Registration capacity		l	100 000 000				
Registration time at Q _n until overrunning to zero		h	128 000	100 000	50 000	16 667	5 000
Outputs 5)							
Pulse value for totalisator		Vol./pulse	pulse value and width parameterisable				
Current 4..20 mA for flowrate		I ₄ /Q ₁ , I ₂₀ /Q ₂	flow rates to 4 and 20 mA parameterisable				
Frequency for flow		f ₁ /Q ₁ , f ₂ /Q ₂	frequency and flowrate parameterisable				
Limiting switch		Q _{min} , Q _{max}	minimum, maximum and hysteresis parameterisable				

1) Manufacturer's specification, valid for the reference conditions as specified under "APPENDIX: Meter data".

2) 1 US gallon corresponds to 3.785 litres.

3) For burners and engines or motors, the meter must be selected on the basis of the permanent flow rate. For higher viscosities, or if the meter is installed on the suction side, the pressure drop and any reduction in the measuring range must be taken into consideration.

4) Weight without couplings.

5) Two freely selectable outputs are available, totally independent of each other.

Pressure drop curves

See "APPENDIX: Meter data"

Electronic display

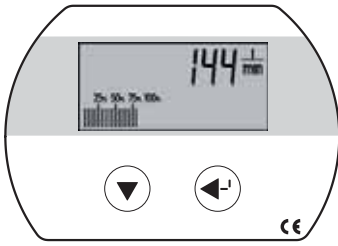

- Display values:
- total volume, resettable volume, flow rate
 - In the information menu, hours of operation and other information can be obtained
- Display:
- 8-character LCD with identification of the parameter, height of numbers: 8 mm, flow rate (meter load) using bar indicator
- Temperature:
- ambient temperature -25 ... +70° C, storage temperature -25 ... +85° C
- Safety:
- CE, vibration and shock test to DIN IEC 68
- Power supply:
- 24 V DC (6...30 V DC)
- Data preservation:
- by non-volatile memory (EEPROM)
- Protection class:
- IP66 (IEC 60529) against water jets and dust

Outputs

Four different output functions are available:

- Pulser for volume pulses with programmable pulse value (for external totaliser)
- Analogue current output 4...20 mA corresponding to flow rate
- Frequency output 0...100 Hz corresponding to flow rate
- Switching function (limiting value switch) specified by programmable upper and lower flow rates

Except for the analogue output function, any two of the remaining three functions can always be used simultaneously. This results in two types of connection:

- 1 potential-free digital output (Rel. 1), parameterisable to one of the three functions described below.
- 1 passive analogue 4...20 mA output also used for powering the meter.
- 2 potential-free digital outputs (Rel. 1 + Rel. 2), each parameterisable to one of the three functions described below.
- the analogue output is not available in this case. The power, however, is supplied over these terminals.

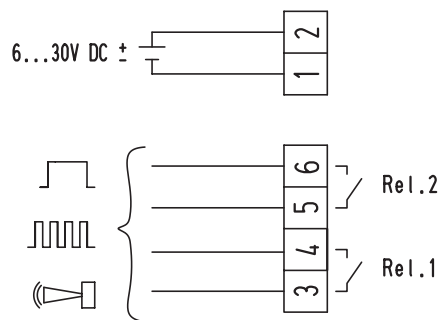
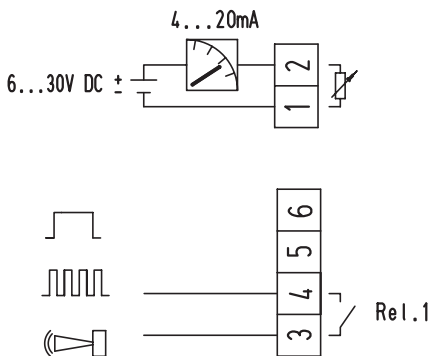

Specification of the outputs

Passive analogue output (1-2)

- Voltage range U: 6...30V DC
- Maximum load R_L : (U-5) V / 0.0215A [Ω]
- Resolution: 16 Bit
- Max. error: ± 0.2 mA
- Update interval: < 1s

Digital outputs (3-4, 5-6)

- Max. voltage U_{max} : 48V AC/DC
- Max. current I_{max} : 50 mA
- Max. output frequency f_{max} : 100 Hz
- Update interval: < 1s
- ON-resistance R_0 : $\leq 100\Omega$
- OFF-resistance R_∞ : $\geq 10M\Omega$
- Insulation voltage: > 100V AC/DC

Adjustable functions:

Volume pulses

- Pulse width t: 5, 50, 250, 500 ms
 Pulse value: parameterisable

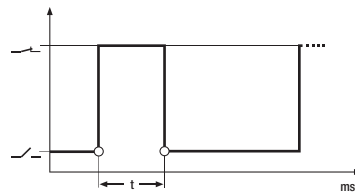

Current signal

- Flow rate at 4 mA Q_1 : parameterisable
- Flow rate 20 mA Q_2 : parameterisable
- Attenuation: parameterisable

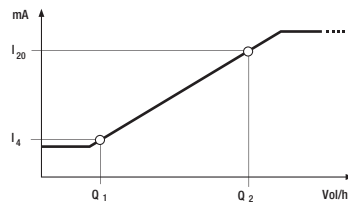

Frequency signal

- Output frequency f_{max} : 100Hz
 Pulse ratio: 1:1
 Frequency / Flowrate f_1/Q_1 : parameterisable
 Frequency / Flowrate f_2/Q_2 : parameterisable

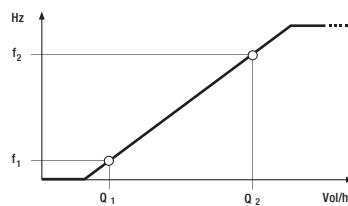

Limiting value switch

- Limit Q_{min} : parameterisable
 Limit Q_{max} : parameterisable
 Hysteresis H: parameterisable

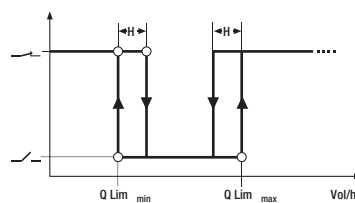

Dimensions

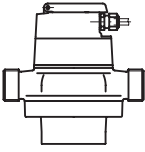
Type	mm	VZF 15	VZF 20	VZF 25	VZF 40	VZF 50
	Length	165	165	190	300	350
	Width	105	105	130	210	280
	Height	155	164	191	243	299

Detailed dimensional diagrams in "APPENDIX: Meter data"

Type designation key

VZF 25 FL 130/25

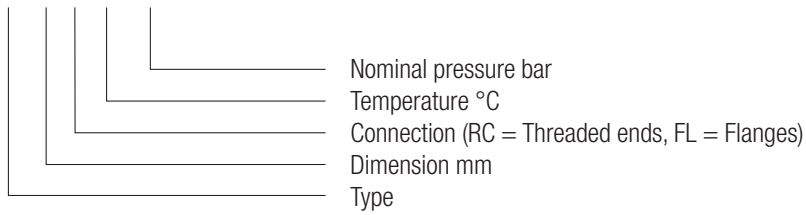

Ordering specifications

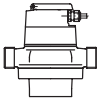
Threaded ends, PN16	Type 130 °C	Order No.
	VZF 15 RC 130/16	93705
	VZF 20 RC 130/16	93708
	VZF 25 RC 130/16	93725
	VZF 40 RC 130/16	93730

Flanges, PN25	Type 130 °C	Order No.	Type 180 °C	Order No.
		VZF 15 FL 130/25	93706	
VZF 20 FL 130/25		93709	VZF 20 FL 180/25	93710
VZF 25 FL 130/25		93726	VZF 25 FL 180/25	93727
VZF 40 FL 130/25		93731	VZF 40 FL 180/25	93732
VZF 50 FL 130/25		93735	VZF 50 FL 180/25	93736

Modification VZF	For marine type approval (e.g. GL, LRS, DNV)	96295
------------------	--	-------