

DS3

SOLENOID OPERATED DIRECTIONAL CONTROL VALVE

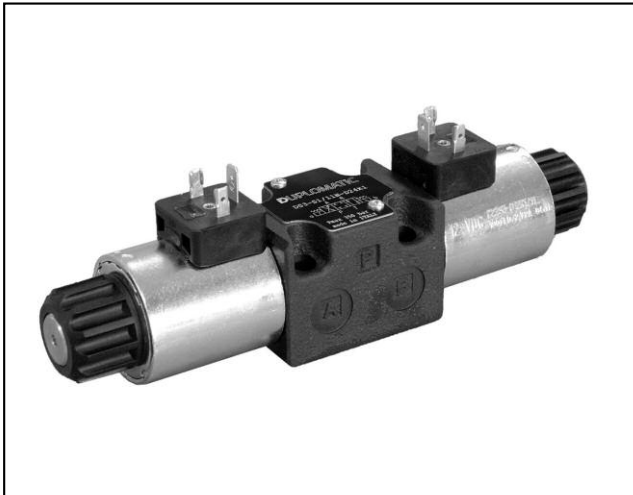

SUBPLATE MOUNTING ISO 4401-03

p max 350 bar
Q max 100 l/min

MOUNTING INTERFACE

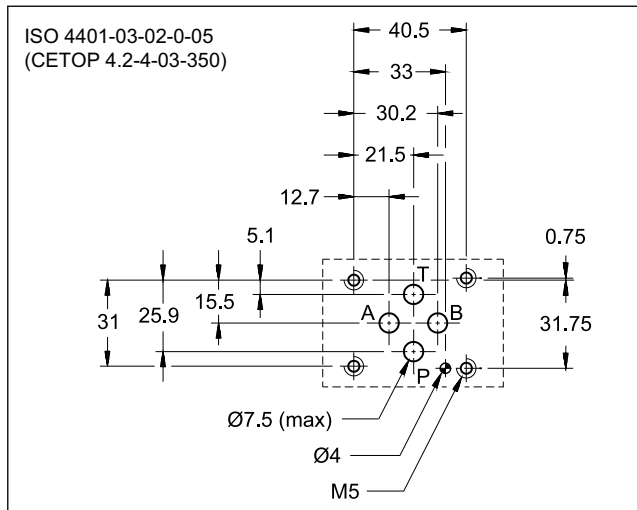

OPERATING PRINCIPLE

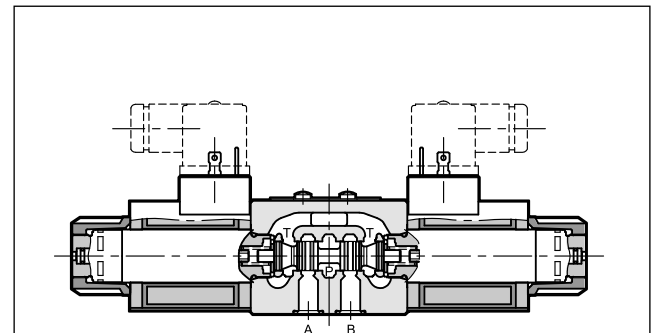

- Solenoid actuated directional control valve, direct operated with mounting surface according to ISO 4401-03 standards.
- The valve is supplied with 3 or 4 ways design, with 2 or 3 positions with a wide range of spools.
- The valve body is made with high strength iron castings provided with wide internal paths in order to minimize the flow pressure drop. Wet armature solenoids with interchangeable coils are used (for further information on solenoids see par. 7).
- The valve is available with DC or AC solenoids. DC solenoids can also be fed with AC power supply, by using connectors with a built-in rectifier bridge (see paragraphs 6.4 and 7.2).
- The DC valve is also available in a soft-shifting version (see par. 14).
- The DC valve is also available with zinc-nickel coating that ensures a salt spray resistance up to 600 hours.
- It is available a version with UL certified 24V DC coils for Canada and United States. (see par. 15).
- Alternative to the standard manual override there are lever, push, knob, push and twist, boot and mechanical detent devices.

PERFORMANCES

(obtained with mineral oil with viscosity of 36 cSt at 50°C)

	bar	CC		CA	
		210	350	160	
Maximum operating pressure: - P - A - B ports - T port					
Maximum flowrate	l/min	100			
Pressure drops $\Delta p-Q$	see paragraph 4				
Operating limits	see paragraph 6				
Electrical features	see paragraph 7				
Electrical connections	see paragraph 11				
Ambient temperature range	°C	-20 / +50			
Fluid temperature range	°C	-20 / +80			
Fluid viscosity range	cSt	10 + 400			
Fluid contamination degree	according to ISO 4406:1999 class 20/18/15				
Recommended viscosity	cSt	25			
Mass:					
single solenoid valve	kg	1,5		1,4	
double solenoid valve	kg	2		2	

1 - IDENTIFICATION CODE

	D	S	3	-		/	11	-		/	
--	----------	----------	----------	----------	--	----------	-----------	----------	--	----------	--

Directional valve, solenoid operated _____

ISO 4401-03 size _____

Spool type (see paragraph 3) _____

S*	RSA*	TA	RK
SA*	RSB*	TB	
SB*		RSA*	
		RSB*	
		TA*	
		TB*	

Series: _____
(the overall and mounting dimensions remain unchanged from 10 to 19)

Seals: _____
N = NBR seals for mineral oil (**standard**)
V = FPM seals for special fluids

DC power supply _____

D12 = 12 V
D14 = 14 V
D24 = 24 V
D28 = 28 V
D48 = 48 V
D110 = 110 V
D125 = 125 V
D220 = 220 V
D00 = valve without coils (see **NOTE 1**)

AC power supply

A24 = 24 V - 50 Hz
A48 = 48 V - 50 Hz
A100 = 100 V - 50 Hz / 100 V - 60 Hz
A110 = 110 V - 50 Hz / 120 V - 60 Hz
A230 = 230 V - 50 Hz / 240 V - 60 Hz
A00 = valve without coils (see **NOTE1**)
F110 = 110 V - 60 Hz
F220 = 220 V - 60 Hz

NOTE 1: Coils locking ring and related OR are supplied together with valves.

NOTE 2: The standard valve is supplied with surface treatment of phosphating black.
The zinc-nickel finishing on the valve body makes the valve suitable to ensure a salt spray resistance up to **240** hours.
For a salt spray resistance up to **600** hours refer to **paragraph 17**.
(test operated according to UNI EN ISO 9227 standards and test evaluation operated according to UNI EN ISO 10289 standards).

Option:
/ W7 = Zinc-nickel surface treatment (see **NOTE 2**)
Not available for AC valves.
Omit if not required

Manual override:
omit for override integrated in the tube (**standard**)
CM = manual override, boot protected
CH = lever manual override (only for DC version). The device is not available for TB, TB* and RSB* spools.
RSA* spools: available only for RSA1 and RSA2.
CP = push manual override (only for DC version)
CK1 = turning knob override (only for DC version)
CK2 = push and twist knob override (only for DC version)
CPK = push manual override with mechanical retention (only for DC version)

Coil electrical connection (see par. 11):
K1 = plug for connector type EN 175301-803 (ex DIN 43650) (**standard**)
K2 = plug for connector type AMP JUNIOR (available on **D12** and **D24** coils only)
K7 = plug DEUTSCH DT04-2P for male connector type DEUTSCH DT06-2S (available on **D12** and **D24** coils only)

2 - HYDRAULIC FLUIDS

Use mineral oil-based hydraulic fluids HL or HM type, according to ISO 6743-4. For these fluids, use NBR seals (code N). For fluids HFDR type (phosphate esters) use FPM seals (code V). For the use of other fluid types such as HFA, HFB, HFC, please consult our technical department.

Using fluids at temperatures higher than 80 °C causes a faster degradation of the fluid and of the seals characteristics. The fluid must be preserved in its physical and chemical characteristics.

3 - SPOOL TYPE

Type **S***:
2 solenoids - 3 positions
with spring centering

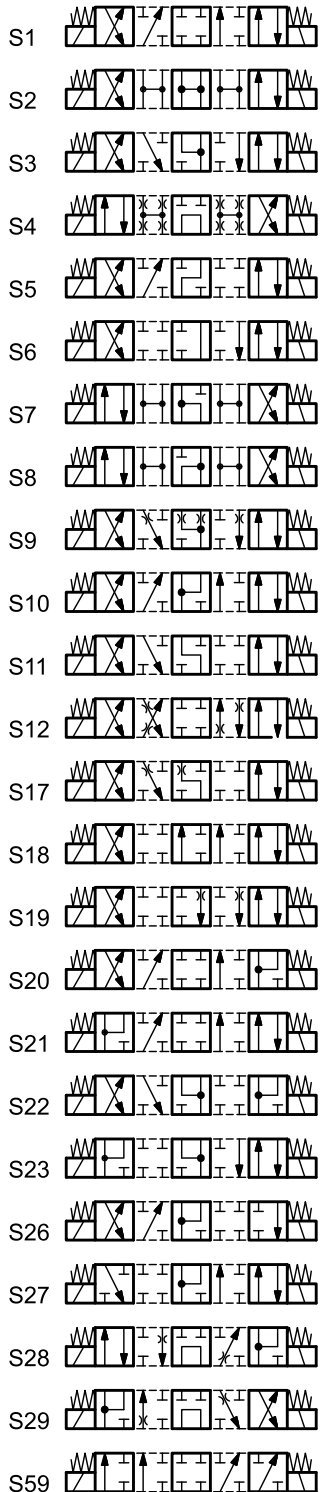
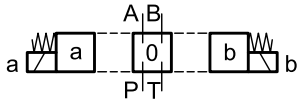

Type **SA***:
1 solenoid side A
2 positions (central + external)
with spring centering

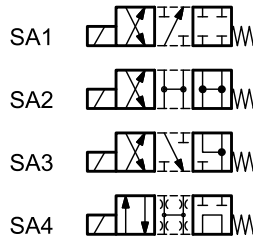
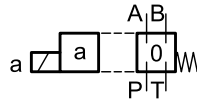

Type **RSA***:
1 solenoid side A
2 positions (external + central)
with return spring

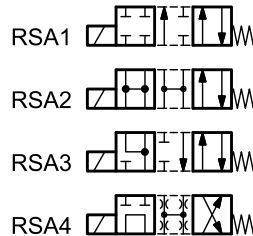
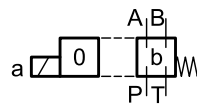

Type **SB***:
1 solenoid side B
2 positions (central + external)
with spring centering

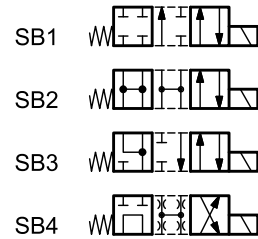
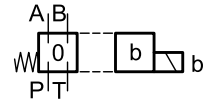

Type **RSB***:
1 solenoid side B
2 positions (external + central)
with return spring

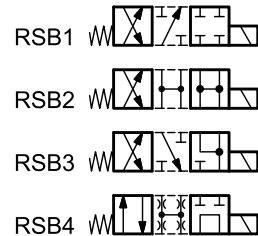
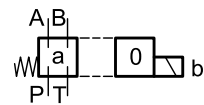

Besides the diagrams shown, which are the most frequently used, other special versions are available: consult our technical department for their identification, feasibility and operating limits.

Type **RK**:
2 solenoids - 2 positions
with mechanical retention

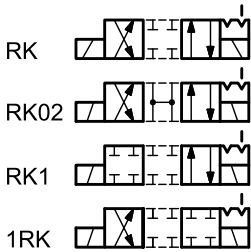
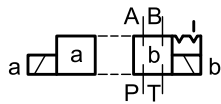

Type **TA**:
1 solenoid side A
2 external positions
with return spring

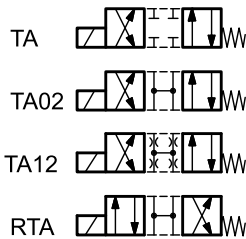
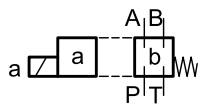

Type **TB**:
1 solenoid side B
2 external positions
with return spring

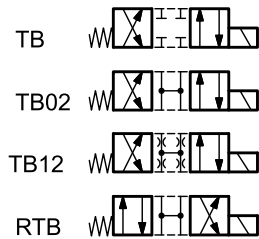
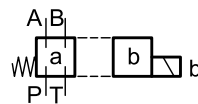

Type **TA***:
1 solenoid side A
2 positions with return spring

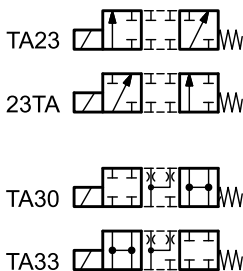
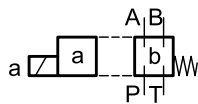

Type **TB***:
1 solenoid side B
2 positions with return spring

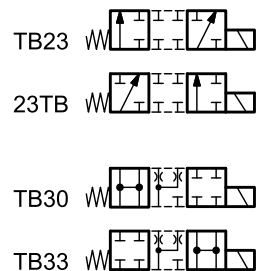
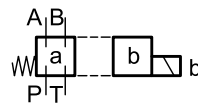

Besides the diagrams shown, which are the most frequently used, other special versions are available: consult our technical department for their identification, feasibility and operating limits.

4 - PRESSURE DROPS Δp -Q

(obtained with viscosity 36 cSt at 50 °C)

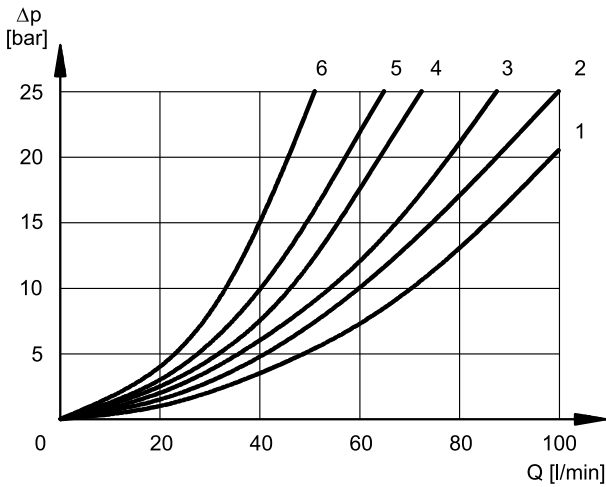

ENERGIZED POSITION

SPOOL TYPE	FLOW DIRECTION			
	P→A	P→B	A→T	B→T
	CURVES ON GRAPH			
S1, SA1, SB1	2	2	3	3
S2, SA2, SB2	1	1	3	3
S3, SA3, SB3, RSA3, RSB3	3	3	1	1
S4, SA4, SB4, RSA4, RSB4	5	5	5	5
S5	2	1	3	3
S6	2	2	3	1
S7, S8	4	5	5	5
S9	2	2	3	3
S10	1	3	1	3
S11	2	2	1	3
S12, S17, S19	2	2	3	3
S18	1	2	3	3
S20, S22	1	5	2	
S21, S23	5	1		2
S28	6	5	-	6
S29	5	6	6	-
S59	3	3	-	-
TA, TB	3	3	3	3
RTA	2	3	3	2
RTB	3	2	2	3
TA02, TB02	2	2	2	2
TA23, TB23	3	3		
RK, RK02, RK1, 1RK	2	2	2	2

DE-ENERGIZED POSITION

SPOOL TYPE	FLOW DIRECTION				
	P→A	P→B	A→T	B→T	P→T
	CURVES ON GRAPH				
S2, SA2, SB2					2
S3, SA3, SB3, RSA3, RSB3			3	3	
S4, SA4, SB4, RSA4, RSB4					3
S5		4			
S6				3	
S7, S8			6	6	3
S10	3	3			
S11			3		
S18	4				
S22, S23			3	3	
S28, S29				6	

5 - SWITCHING TIMES

The values indicated are obtained according to ISO 6403 standard, with mineral oil viscosity 36 cSt at 50 °C.

SPOOL TYPE	TIMES [ms]	
	ENERGIZING	DE-ENERGIZING
CC	25 ÷ 75	15 ÷ 25
CA	10 ÷ 25	15 ÷ 40

6 - OPERATING LIMITS

The curves define the flow rate operating fields according to the valve pressure of the different versions. The values have been obtained according to ISO 6403 norm with solenoids at rated temperature and supplied with voltage equal to 90% of the nominal voltage. The value have been obtained with mineral oil, viscosity 36 cSt, temperature 50 °C and filtration according to ISO 4406:1999 class 18/16/13.

The limits for TA02 and TA spools refer to the 4-way operation. The operating limits of a 4-way valve in 3-way operation or with port A or B plugged or without flow are shown in the chart on the next page. The performance of the DC solenoid powered by AC with rectifier connectors are at par. 6.4. The performances of the soft-shift valve are shown at par. 14.

6.1 - Valves in standard operation

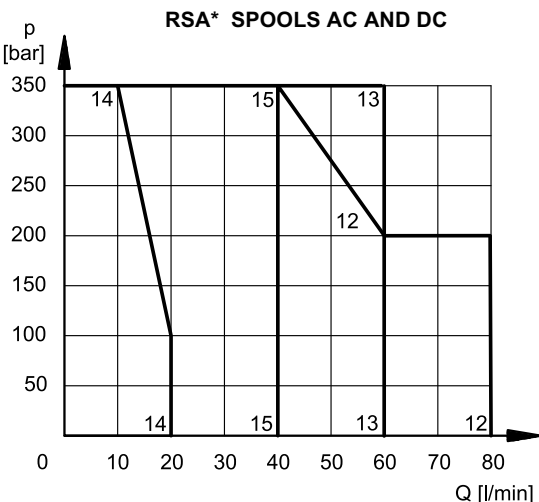
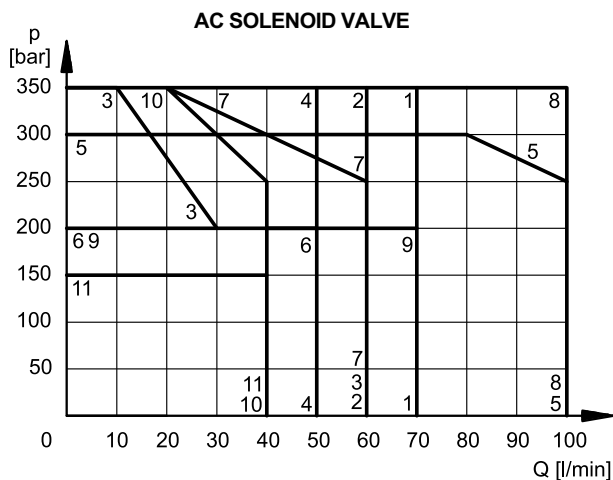
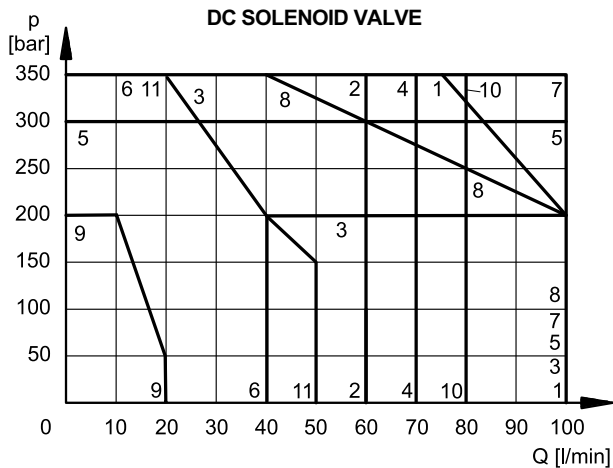

DC SOLENOID VALVE

SPOOL	CURVE	
	P→A	P→B
S1,SA1,SB1	1	1
S2, SA2, SB2	2	2
S3, SA3, SB3	3	3
S4, SA4, SB4	4	4
S5	5	5
S6	4	6
S7	4	4
S8	4	4
S9	7	7
S10	7	7
S11	4	6
S12	1	1
S17	4	4
S18	5	5
S19	4	4
S20	6*	6
S21	6	6*
S22	6	6
S23	6	6
S28	9*	9*
S29	9*	9*
S59	10	10
TA, TB	7	7
TA02, TB02	8	8
TA23, TB23	2	2
TA 30	1	-
RTA, RTB	11	11
RK	7	7
RK02	8	8
RK1, 1RK	7	7

AC SOLENOID VALVE

SPOOL	CURVE	
	P→A	P→B
S1,SA1,SB1	1	1
S2, SA2, SB2	2	2
S3, SA3, SB3	3	3
S4, SA4, SB4	2	2
S5	5	5
S6	6	6
S7	4	4
S8	4	4
S9	7	7
S10	8	8
S11	6	6
S12	2	2
S17	7	7
S18	5	5
S19	7	7
S20	10*	10
S21	10	10*
S22	10*	10
S23	10	11*
S28		
S29		
S59		
TA, TB	1	1
TA02, TB02	1	1
TA23, TB23	2	2
TA 30	5	-
RTA, RTB	11	11
RK	8	8
RK02	9	9
RK1, 1RK	8	8

* Performance obtained for a valve with A and B lines connected the one to the piston-side chamber and the other to the rod-side chamber of a double-acting cylinder with area ratio 2:1.

SPOOL	CURVE
RSA1	12
RSA2	13
RSA3	14
RSA4	15

6.2 - 4-way valve in 3-way operation

Operating limits of a 4-way valve in 3-way operation or with port A or B plugged or without flow.

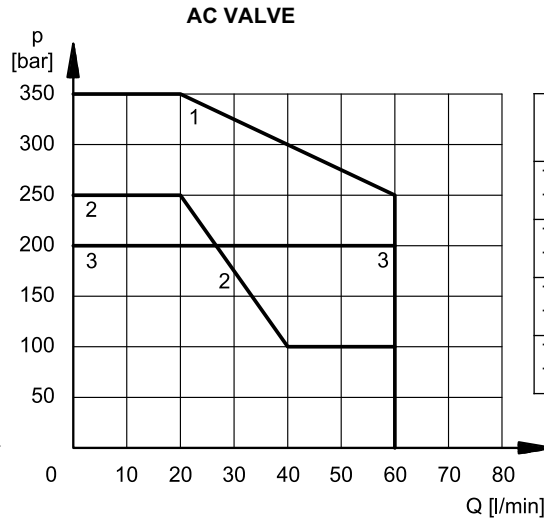
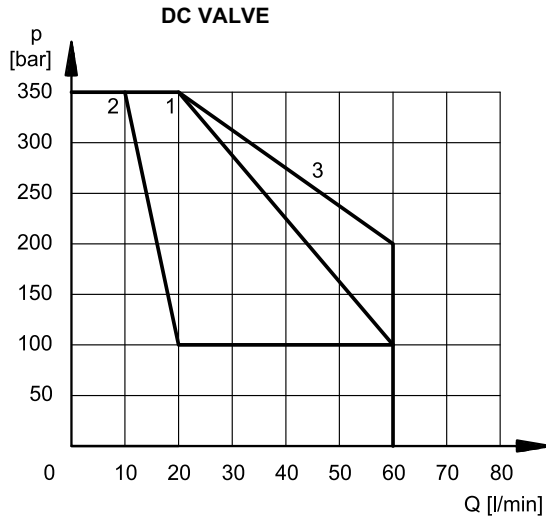

SPOOL	CURVE	
	DC	AC
TA backpr. A TB backpr. B	1	1
TA02 backpr. A TB02 backpr. B	1	1
TA backpr. B TB backpr. A	2	1
TA02 backpr. B TB02 backpr. A	3	3

6.3 - AC solenoid valve with coil A110 fed with 110V - 60 Hz

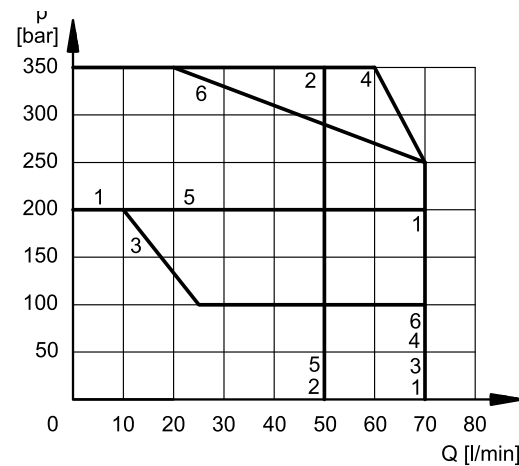

SPOOL	CURVE	
	P→A	P→B
S1, SA1, SB1	1	1
S2, SA2, SB2	2	2
S3, SA3, SB3	3	3
S4, SA4, SB4	4	4
S9	5	5
TA, TB	2	2
RK	6	6

6.4 - Operating limits for DC solenoid valves fed with AC with rectifier connectors

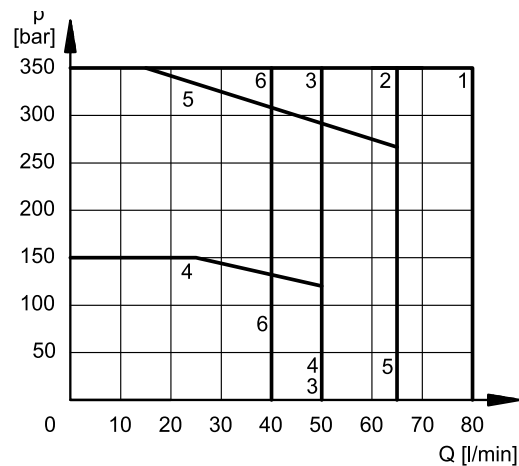

SPOOL	CURVE	
	P→A	P→B
S1, SA1, SB1	2	2
S2, SA2, SB2	3	3
S3, SA3, SB3	4	4
S4, SA4, SB4	2	2
S9	5	5
TA, TB	6	6
RK	1	1

7 - ELECTRICAL FEATURES

7.1 - Solenoids

These are essentially made up of two parts: tube and coil. The tube is threaded into the valve body and includes the armature that moves immersed in oil, without wear. The inner part, in contact with the oil in the return line, ensures heat dissipation. The coil is fastened to the tube by a threaded ring, and can be rotated 360°, to suit the available space.

Protection from atmospheric agents IEC 60529

The IP protection degree is guaranteed only with both valve and connectors of an equivalent IP degree, correctly connected and installed.

electric connection	electric connection protection	whole valve protection
K1 EN 175301-803 (ex DIN 43650)	IP65	IP65
K2 AMP JUNIOR	IP65/67	
K7 DEUTSCH DT04 male	IP65/67	

SUPPLY VOLTAGE FLUCTUATION	± 10% Vnom
MAX SWITCH ON FREQUENCY	18.000 ins/hr
DUTY CYCLE	100%
ELECTROMAGNETIC COMPATIBILITY (EMC) (NOTE)	In compliance with 2014/30/EU
LOW VOLTAGE	In compliance with 2014/35/EU
CLASS OF PROTECTION : Coil insulation (VDE 0580) Impregnation: DC valve AC valve	class H class F class H

NOTE: In order to further reduce the emissions, with DC supply, use of type H connectors is recommended. These prevent voltage peaks on opening of the coil supply electrical circuit (see cat. 49 000).

7.2 - Current and absorbed power for DC solenoid valve

The table shows current and power consumption values of the DC coils.

Using connectors type "D" (see cat. 49 000) with embedded bridge rectifier it is possible to feed DC coils (starting from 48V voltage) with alternating current (50 or 60 Hz), considering a reduction of the operating limits (see diagram at section 6.4).

Coils for direct current (values ± 10%)

	Nominal voltage [V]	Resistance at 20°C [Ω]	Current consumpt. [A]	Power consumpt [W]	Coil code		
					K1	K2	K7
D12	12	4,4	2,72	32,7	1903080	1903100	1902940
D14	14	7,2	1.93	27	1903086		
D24	24	18,6	1,29	31	1903081	1903101	1902941
D28	28	26	1,11	31	1903082		
D48	48	78,6	0,61	29,5	1903083		
D110	110	423	0,26	28,2	1903464		
D125	125	550	0,23	28,6	1903467		
D220	220	1692	0,13	28,2	1903465		

7.3 - Current and absorbed power for AC solenoid valve

The table shows current and power consumption values at inrush and at holding, for AC coils.

Coils for alternating current (values ± 5%)

Suffix	Nominal Voltage [V]	Freq. [Hz]	Resistance at 20°C [Ω]	Current consumption at inrush [A]	Current consumption at holding [A]	Power consumption at inrush [VA]	Power consumption at holding [VA]	Coil Code K1
A24	24	50	1,69	5,81	1,32	139	32	1902830
A48	48		6,02	3,78	0,86	182	41	1902831
A100	100V-50Hz 100V-60Hz	50/60	23,3	2,11	0,48	211	48	1902836
				1,63	0,37	163	37	
A110	110V-50Hz 120V-60Hz		33	1,76	0,40	194	44	1902832
				1,54	0,35	185	42	
A230	230V-50Hz 240V-60Hz		135	0,92	0,21	213	48	1902833
				0,79	0,18	190	43	
F110	110	60	28,5	1,45	0,33	160	36	1902834
F220	220		103	0,92	0,21	203	46	1902835

8 - OVERALL AND MOUNTING DIMENSIONS FOR DC SOLENOID VALVES

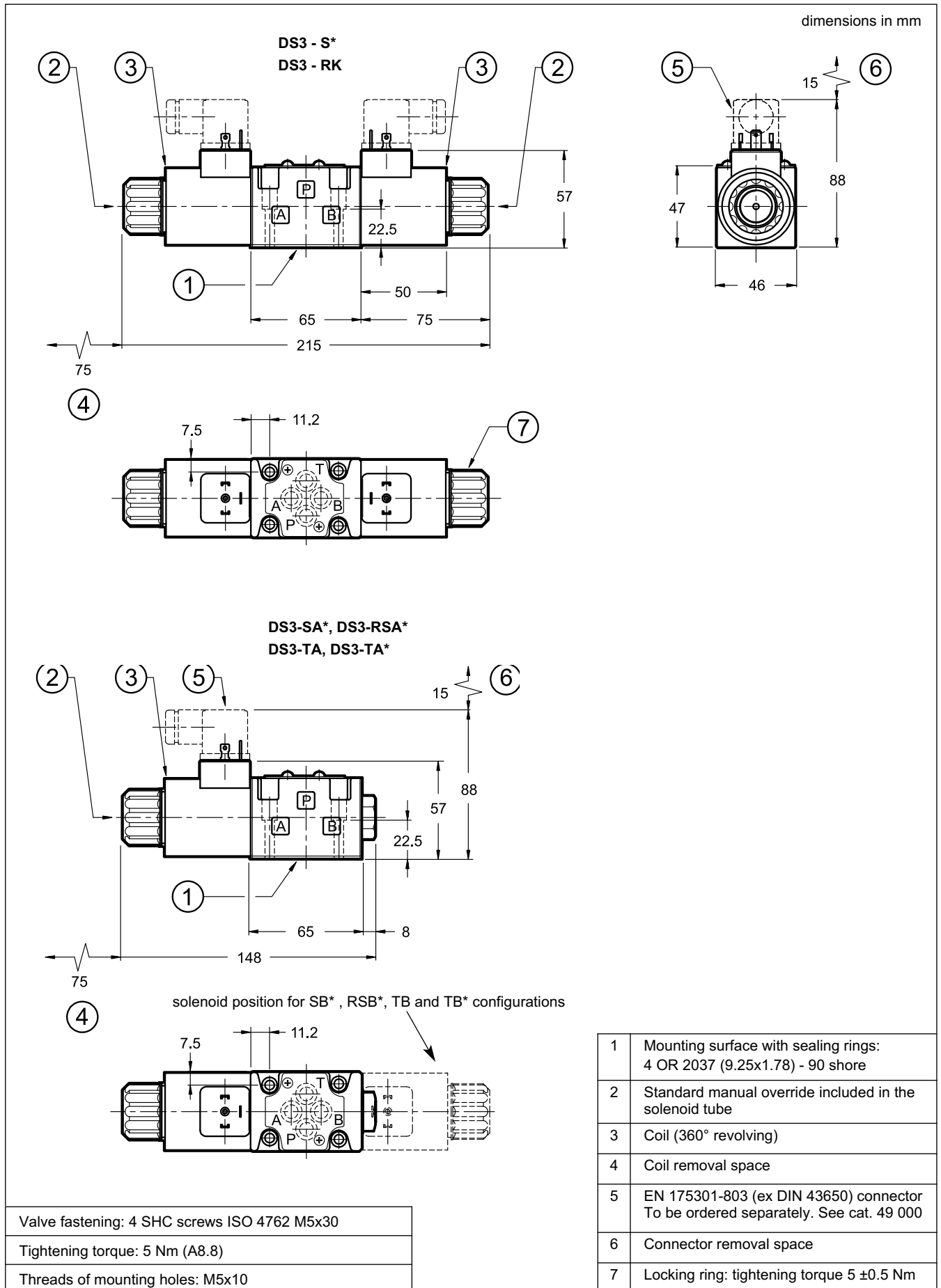

9 - OVERALL AND MOUNTING DIMENSIONS FOR AC SOLENOID VALVES

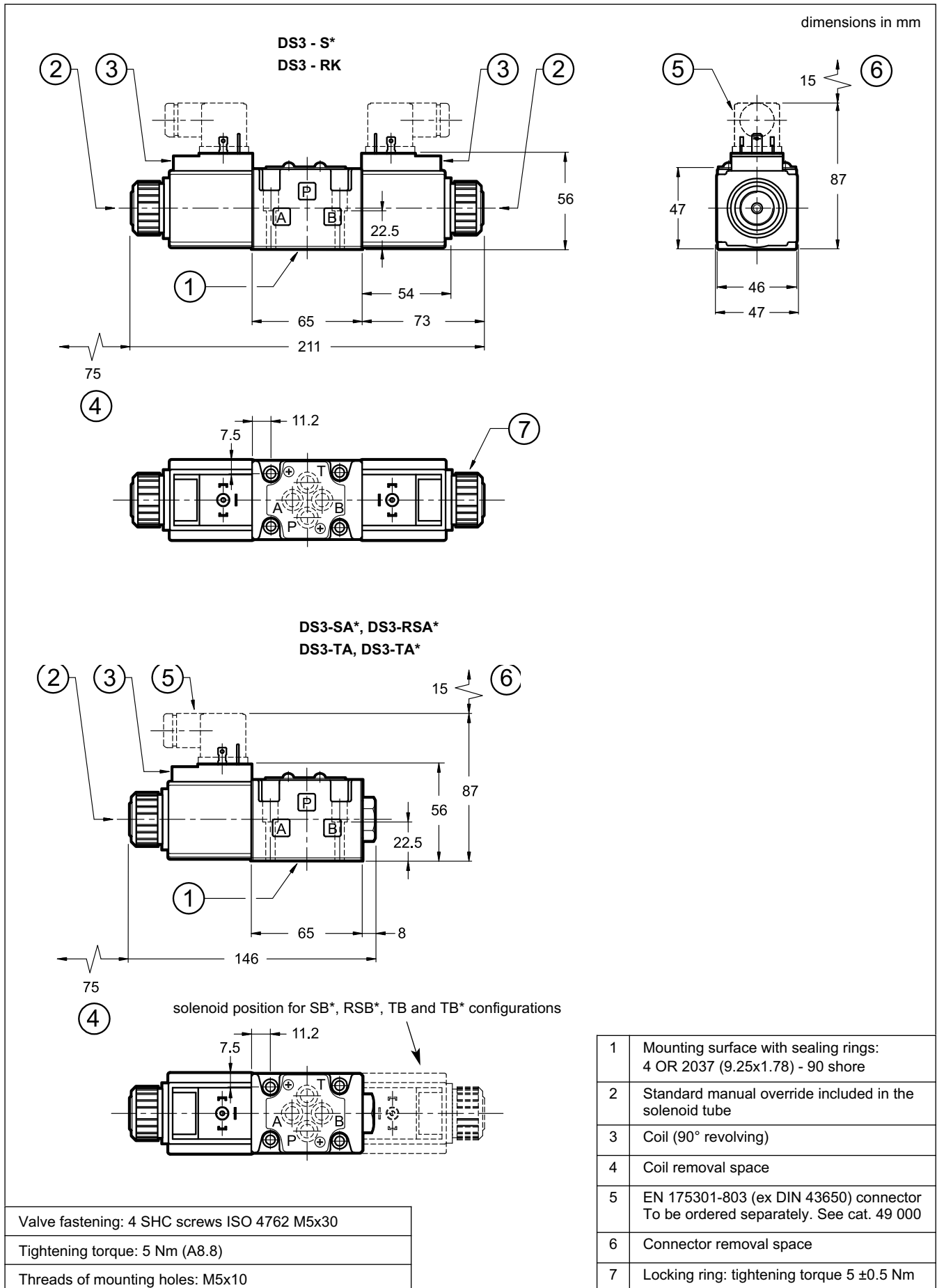

10 - INSTALLATION

Configurations with centering and return springs can be mounted in any position; type RK valves - without springs and with mechanical detent - must be mounted with the longitudinal axis horizontal.

Valve fixing takes place by means of screws or tie rods, with the valve mounted on a lapped surface, with values of planarity and smoothness that are equal to or better than those indicated in the drawing. If the minimum values of planarity and/or smoothness are not met, fluid leakages between valve and mounting surface can easily occur.

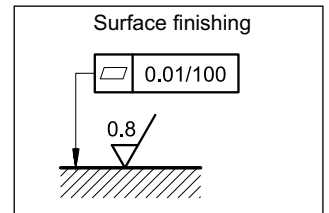

11 - ELECTRIC CONNECTIONS

connection for EN 175301-803
(ex DIN 43650) connector
code **K1 (standard)**
code **WK1** (W7 version only)

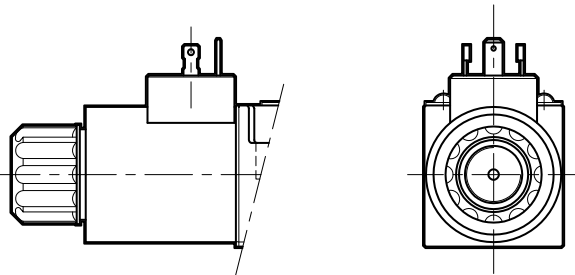

connection for AMP JUNIOR
connector
code **K2**

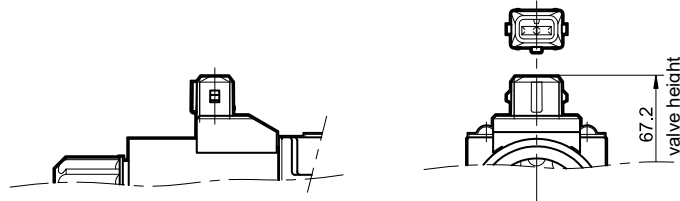

connection for
DEUTSCH DT06-2S male connector
code **K7**



connection for
DEUTSCH DT06-2S male connector
code **WK7** (W7 version only)
code **WK7D** (W7 version only - coil
with diode)

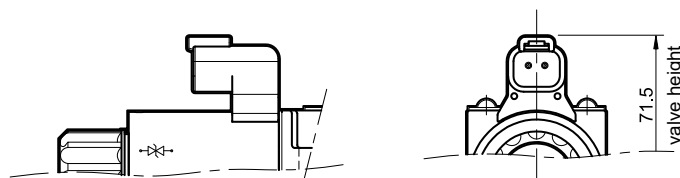

12 - ELECTRIC CONNECTORS

Solenoid operated valves are delivered without connectors. Connectors type EN 175301-803 (ex DIN 43650) for K1 connections can be ordered separately. See catalogue 49 000.

13 - MANUAL OVERRIDES

13.1 - Manual override, boot protected

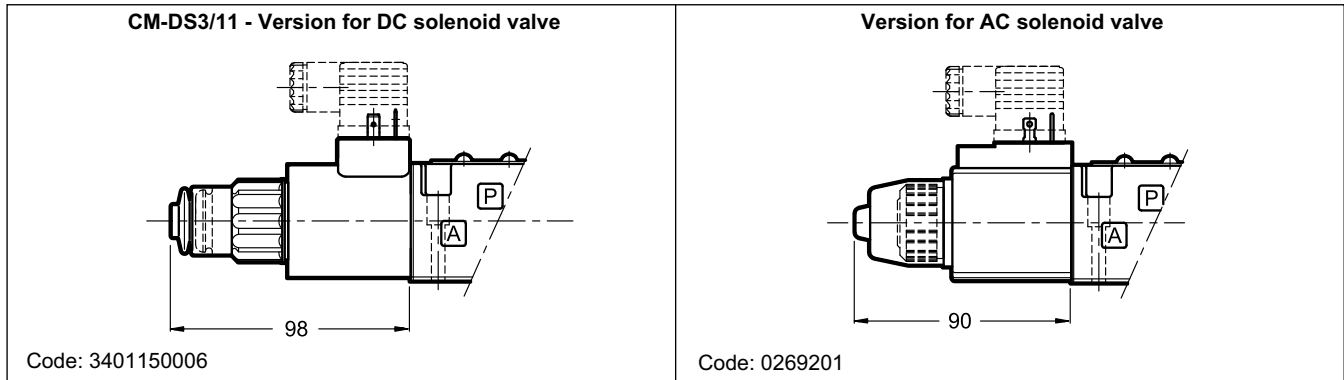

13.2 - CH-DS3/11 Lever manual override (only for DC solenoid valve)

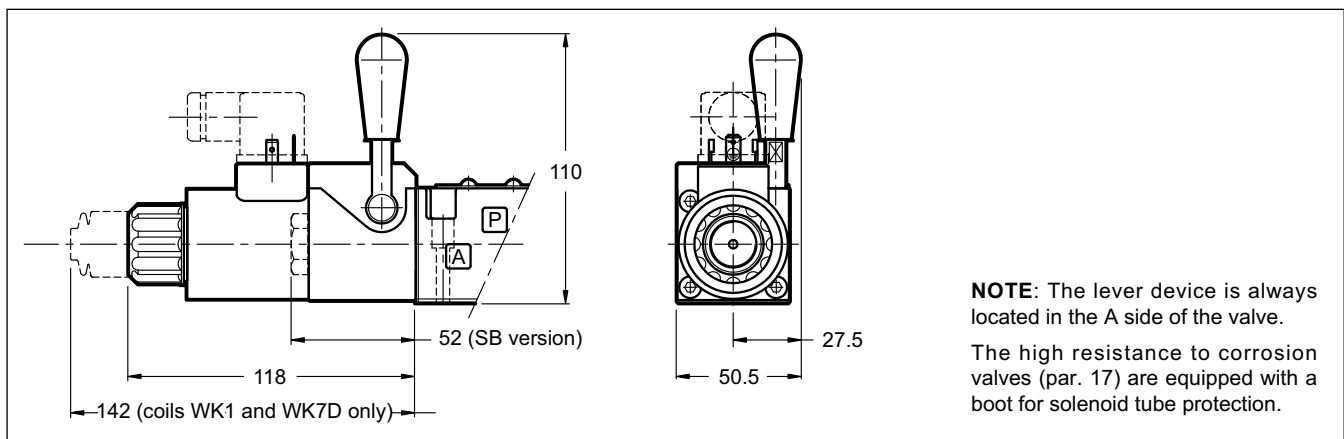

13.3 - CP-DS3/10 Push manual override (only for DC solenoid valve)

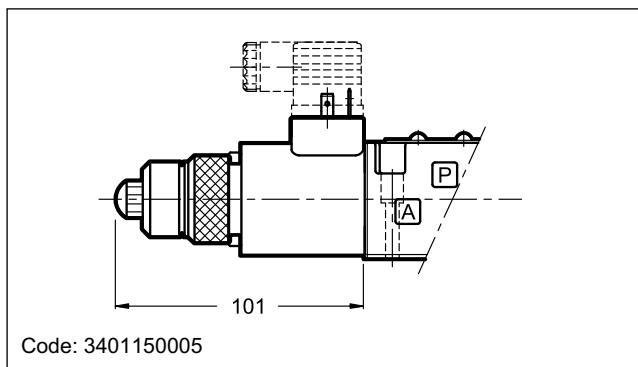

13.4 - CK1-DS3/11 knob manual override, turning (only for DC solenoid valve)

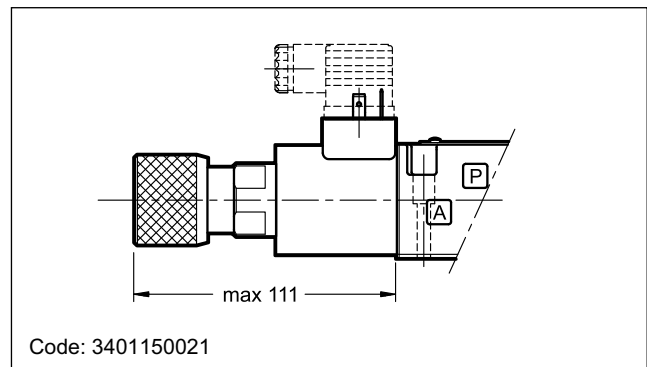

13.5 - CPK-DS3/10 Push manual override with mechanical retention (only for DC solenoid valve)

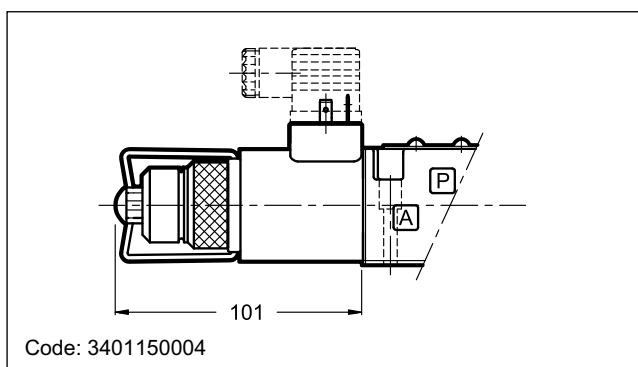

13.6 - CK2-DS3/10 Push and twist manual override (only for DC solenoid valve)

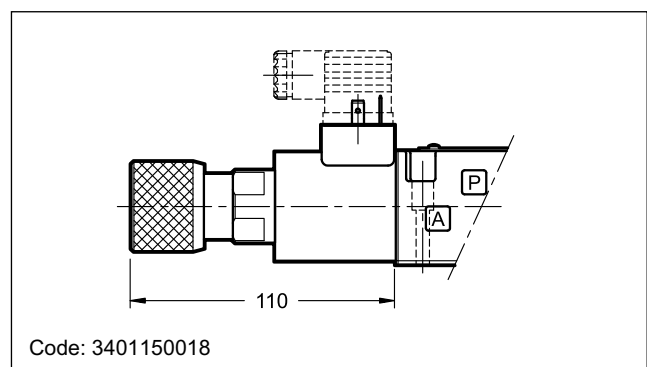

14 - SOFT-SHIFT VERSION FOR DC VALVE

14.1 - Identification code

	D	S	3	-		/	13	-		/	F	
--	----------	----------	----------	---	--	---	-----------	---	--	---	----------	--

Solenoid operated directional control valve

ISO 4401-03 size _____

Spool type _____
The hydraulic symbols of S2F and S4F are identical to those of S2 and S4 spools (p.2)

S1	TA12
S2F	TB12
S4F	TA23
S9	TB23
S12	

Series: _____
(the overall and mounting dimensions remain unchanged from 10 to 19)

Seals: _____
N = NBR seals for mineral oil (**standard**)
V = FPM seals for special fluids

Option:
/W7 = see par. 1

Manual override
(see par.1 and 13)

Soft-shifting

Coil electrical connection
(see par. 11):
K1 = plug for connector type EN 175301-803 (ex DIN 43650) (**standard**)
K2 = plug for connector type AMP JUNIOR (available on **D12** and **D24** coils only)
K7 = plug DEUTSCH DT04-2P for male connector type DEUTSCH DT06-2S (available on **D12** and **D24** coils only)

DC power supply
D12 = 12 V
D24 = 24 V
D28 = 28 V
D110 = 110 V
D220 = 220 V

This version enables hydraulic actuators to perform a smooth start and stop by reducing the speed of movement of the valve spool.

In this version, the S9 spool must be used instead of the S3 type.

The diagram on the side shows the operating limits of the spools available in the soft-shifting version, while the table shows the switching times.

The values indicated are obtained according to ISO 6403 standard, with mineral oil viscosity 36 cSt at 50°C.

The shifting time and characteristics curves are influenced by the viscosity (and thus by the temperature) of the operating fluid. Moreover, times can vary according to the flow rate and operating pressure values of the valve.

For correct operation of the soft-shifting ensure the solenoid tubes are always filled with oil. At this matter, we recommend to install a backpressure valve set at 1 ÷ 2 bar on T line.

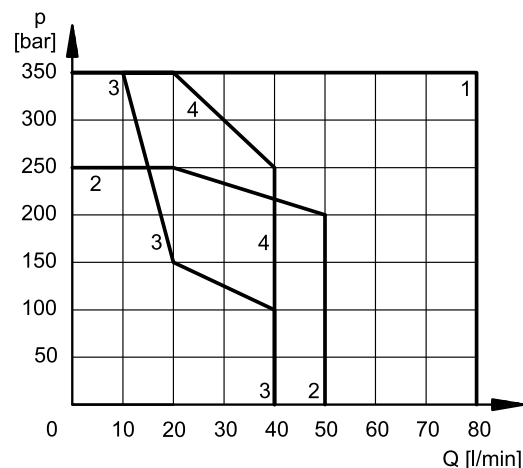

SPOOL	CURVE	TIMES [ms]	
		ENERGIZING	DE-ENERGIZING
S1, S12	1	350	200 + 300
S2F	2	400	100 + 250
S4F	4	350	150 + 300
S9	1	400	200 + 300
TA12, TB12	3	180	200 + 300
TA23, TB23		300	200 + 300

15 - VERSION WITH UL CERTIFIED COILS

15.1 - Identification code

	D	S	3	-		/	11		-	D24	UL	K1	/	
Solenoid operated directional control valve ISO 4401-03 size _____ Spool type _____ See paragraph 3 Series: _____ (the overall and mounting dimensions remain unchanged from 10 to 19) Seals: _____ N = NBR seals for mineral oil (standard) V = FPM seals for special fluids										Manual override: omit for override integrated in the tube (standard) CM = manual override, boot protected Coil electrical connection for connector type EN 175301-803 (ex DIN 43650) LISK coil, UL certified to United States and Canada. Class 155 (F)				
										Power supply DC 24 V				

15.2 - UL file number

The UL database website provides informations about the certification, by entering the code MH29222 in the 'UL file number' field.

15.3 - Electrical features

(values ± 10%)

	Nominal voltage [V]	Resistance at 20°C [Ω]	Current consumpt. [A]	Power consumpt [W]	Coil code
D24ULK1	24	19.2	1.25	30	1903341

NOTE: Valves with UL coils must be ordered complete. **The UL coils are not interchangeable with those of standard valves.**

15.4 - Overall and mounting dimensions

dimensions in mm

Valve fastening: 4 SHC screws ISO 4762 M5x30	1 Standard manual override included in the solenoid tube
Tightening torque: 5 Nm (A8.8)	2 CM version: boot manual override, rubber
Threads of mounting holes: M5x10	

16 - VERSION WITH FIXING INTERCHANGEABLE WITH 4WE6*6X REXROTH

16.1 - Identification code

D	S	3	R	-	/	11	-		/	
----------	----------	----------	----------	----------	----------	-----------	----------	--	----------	--

Directional valve, solenoid operated

ISO 4401-03 size

Fastening screws interchangeable with Rexroth 4WE6*6X valve.

Spool type (see paragraph 3)

S*	RSA*	TA	RK
SA*	RSB*	TB	
SB*		TA*	
		TB*	

Series: (the overall and mounting dimensions remain unchanged from 10 to 19)

Complete the identification code configuration as for in paragraph 1.

16.2 - Overall and mounting dimensions for DC solenoid valves

dimensions in mm

Please refer to the standard valve at paragraph 8 for non-quoted dimensions.

Valve fastening: 4 SHC screws ISO 4762 M5x50
Tightening torque: 5 Nm (A8.8)
Threads of mounting holes: M5x10

16.3 - Overall and mounting dimensions for AC solenoid valves

dimensions in mm

Please refer to the standard valve at paragraph 9 for non-quoted dimensions.

Valve fastening: 4 SHC screws ISO 4762 M5x50
Tightening torque: 5 Nm (A8.8)
Threads of mounting holes: M5x10

17 - HIGH IP AND CORROSION RESISTANCE VERSION

17.1 - Identification code

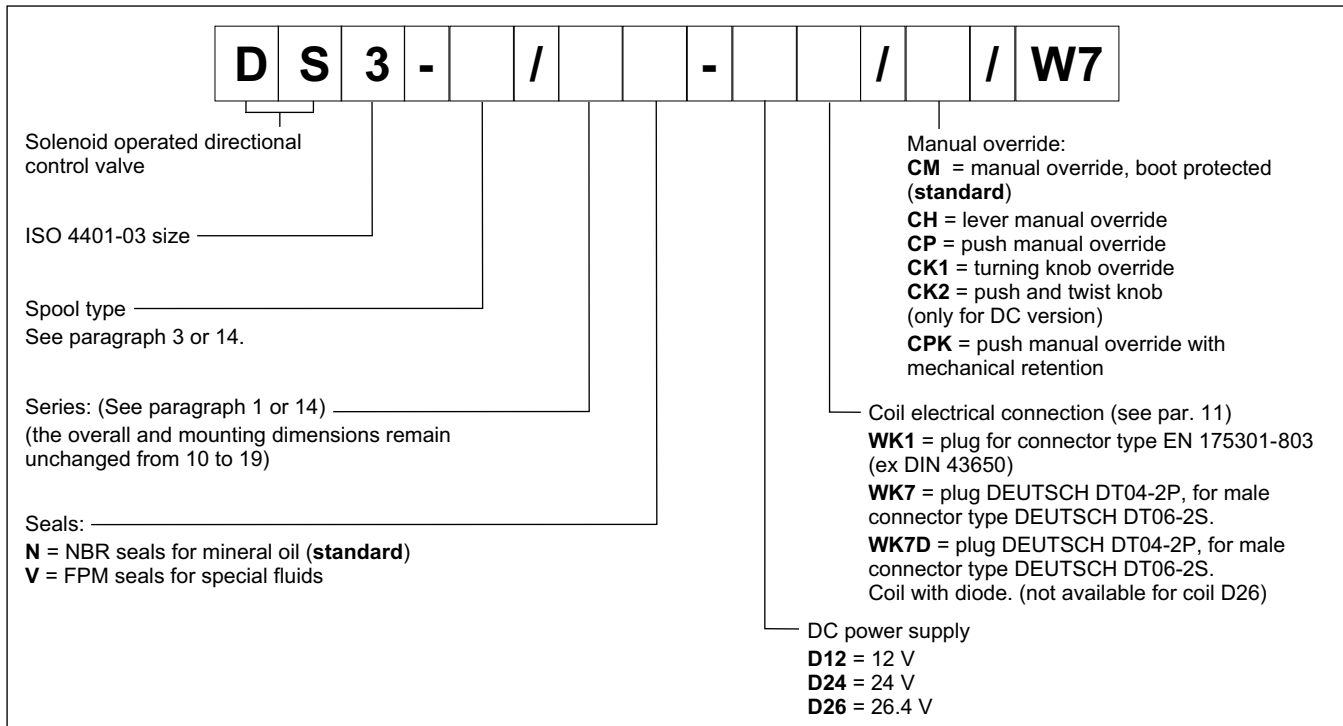

17.2 - Corrosion resistance

This version features the zinc-nickel coating on all exposed metal parts of the valve, making it resistant to exposure to the salt spray for **600** hours (test performed according to UNI EN ISO 9227 and assessment test performed according to UNI EN ISO 10289).

17.3 - DC coils

The coils feature a zinc-nickel surface treatment.

The WK7D coil includes a suppressor diode of pulses for protection from voltage peaks during switching. During the switching the diode significantly reduces the energy released by the winding, by limiting the voltage to 31.4V in the D12 coil and to 58.9 V in the D24 coil.

(values ±10%)

	Nominal voltage [V]	Resistance at 20°C [Ω]	Current consumpt. [A]	Power consumpt [W]	Coil code		
					WK1	WK7	WK7D
D12	12	4,4	2,72	32,7	1903590	1903580	1903600
D24	24	18,6	1,29	31	1903591	1903581	1903601
D26	26,4	21,8	1,21	32	1903599	1903589	-

17.4 - Protection from atmospheric agents IEC 60529

The IP protection degree is guaranteed only with both valve and connectors of an equivalent IP degree, correctly connected and installed.

electric connection	electric connection protection	whole valve protection
WK1 EN 175301-803 (ex DIN 43650)	IP66	IP66
WK7 DEUTSCH DT04 male	IP66/IP68/IP69 IP69K*	IP66/IP68/IP69 IP69K*
WK7D DEUTSCH DT04 male	IP66/IP68/IP69 IP69K*	IP66/IP68/IP69 IP69K*

(*) The IP69K protection degree is not taken into account in IEC 60529 but it is included in ISO 20653.

NOTE: As regards the liquid ingress protection (second digit), there are three means of protection.

Codes from 1 to 6 are related to water jets.

Rates 7 and 8 are related to immersion.

Rate 9 is reserved for high pressure and temperature water jets.

This means that IPX6 covers all the lower steps, rate IPX8 covers IPX7 but not IPX6 and lower, instead IPX9 does not cover any of them.

Whether a device meets two types of protection requirements it must be indicated by listing both the tests separated by a slash.

(E.g. a marking of an equipment covered both by temporary immersion and water jets is IP66/IP68).

18 - PORT RESTRICTORS

Port restrictors are recommended if flow variations which exceed the valve performance limit during the switching processes occur, or for circuit dampening.

Port restrictor plugs can be ordered separately with the part numbers shown at left.

Ø (mm)	part number
blank	0144162
0.6	0144163
0.8	0144033
1	0144034

Ø (mm)	part number
1.2	0144035
1.5	0144036
1.8	0144164
2	0144165

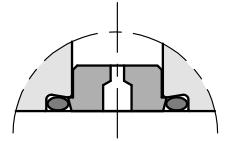

19 - SPARE PARTS FOR DC SOLENOID VALVE

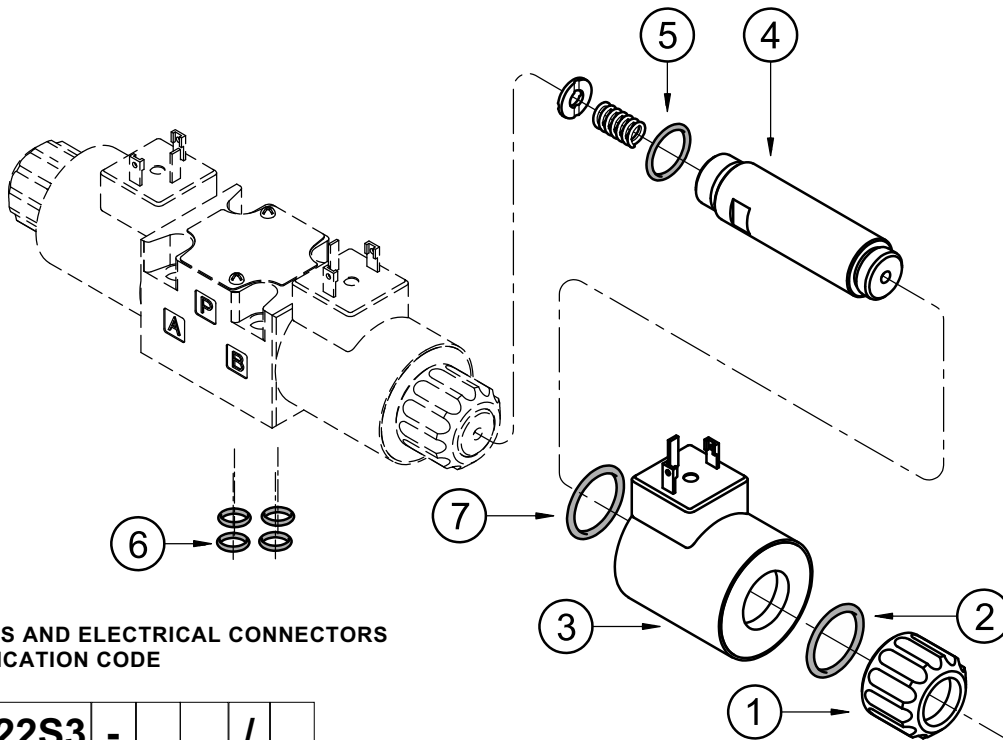

DC COILS AND ELECTRICAL CONNECTORS IDENTIFICATION CODE

C 22S3 - /

Supply voltage

D12 = 12 V
D14 = 14 V
D24 = 24 V
D26 = 26.4 V
D28 = 28 V
D48 = 48 V
D125 = 125 V
D110 = 110 V
D220 = 220 V

Series no.:

10 = for K7 and WK7
11 = for K1 up to D48 and K2
12 = for K1 D110, D125, D220, WK1 and WK7D

Coil electrical connection (see par. 11):
K1 = plug for connector EN 175301-803 (ex DIN 43650)

for coils **D12**, **D24** and **D26**:

WK1 = plug for connector EN 175301-803 (ex DIN 43650)

WK7 = plug DEUTSCH DT04-2P, for male connector type DEUTSCH DT06-2S.

Only for **D12** and **D24**:

K2 = plug for connector AMP JUNIOR
K7 = plug DEUTSCH DT04-2P, for male connector type DEUTSCH DT06-2S.

WK7D = plug DEUTSCH DT04-2P, for male connector type DEUTSCH DT06-2S.
 Coil with diode.

1	Coil locking ring with seal included cod. 0119412 Tightening torque 5 ±0.5 Nm
2	ORM type 0220-20 (22x2) - 70 Shore
3	Coil (see identification code)
4	Solenoid tube for standard version: TD22-DS3/10N (NBR seals) TD22-DS3/10V (FPM seals) Solenoid tube for version with soft-shifting: TD22-DS3F/10N (NBR seals) TD22-DS3F/10V (FPM seals) NOTE: OR n°5 included
5	OR type 2062 (15.6x1.78) - 70 Shore
6	4 OR type 2037 (9.25x1.78) - 90 Shore
7	For coils WK* only: ORM-0220-20 - MVQ

SEALS KIT

The codes include the O-Ring n° 2, 5, 6 e 7.

Cod. 1985406 NBR seals
Cod. 1985410 FPM (viton) seals

NOTE: You can also order coils using the coil codes in paragraphs 7.2 and 17.3.

20 - SPARE PARTS FOR AC SOLENOID VALVE

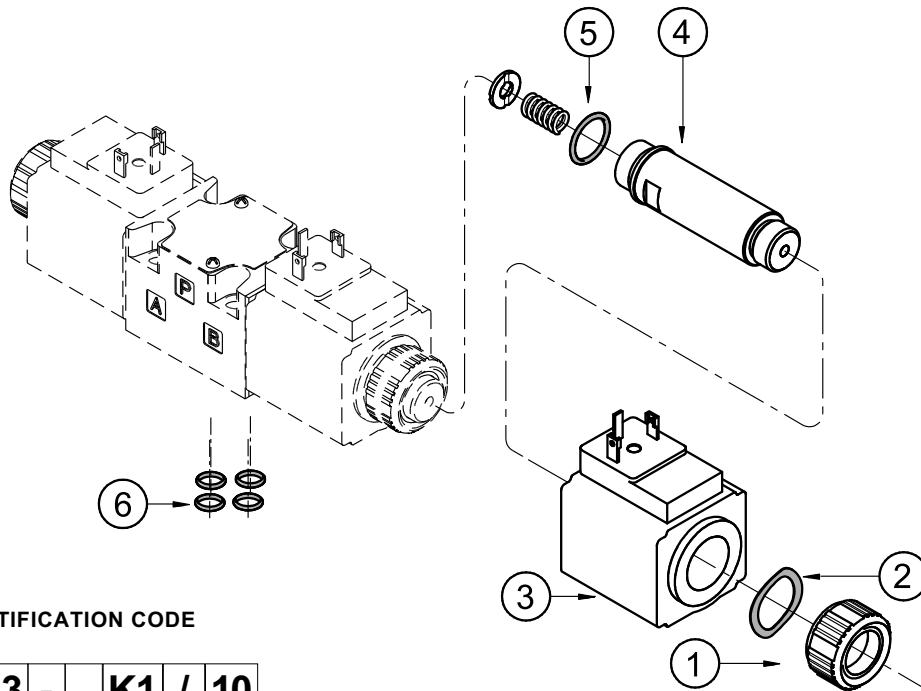

AC COILS IDENTIFICATION CODE

C 20.6S3 - K1 / 10

Supply voltage

- A24** = 24 V - 50 Hz
- A48** = 48 V - 50 Hz
- A100** = 100 V - 50 Hz
100 V - 60 Hz
- A110** = 110 V - 50 Hz
120 V - 60 Hz
- A230** = 230 V - 50 Hz
240 V - 60 Hz
- F110** = 110 V - 60 Hz
- F220** = 220 V - 60 Hz

Series no.:
(the overall and mounting dimensions remain unchanged from 10 to 19)

Plug for connector type
EN 175301-803
(ex DIN 43650)

1	Coil locking ring cod. 0119333 Tightening torque 5 ±0.5 Nm
2	Snap ring cod. 0550483
3	Coil (see identification code on the side)
4	Solenoid tube : TA20.6-DS3/10N (NBR seals) TA20.6-DS3/10V (FPM seals) NOTE: OR n° 5 included
5	OR type 2062 (15.6x1.78) - 70 Shore
6	N. 4 OR type 2037 (9.25x1.78) - 90 Shore

SEALS KIT

The codes include the OR nr. 5 and 6.

Cod. 1985406 NBR seals

Cod. 1985410 FPM (viton) seals

NOTE: You can also order coils using the coil codes in paragraph 7.3

21 - SUBPLATES

(see catalogue 51 000)

Type PMMD-AI3G with rear ports 3/8" BSP

Type PMMD-AL3G with side ports 3/8" BSP