

Drehmomentstützen

DS N

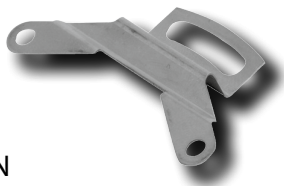

DS A

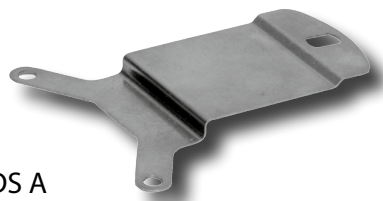

Mechanische Abmessungen

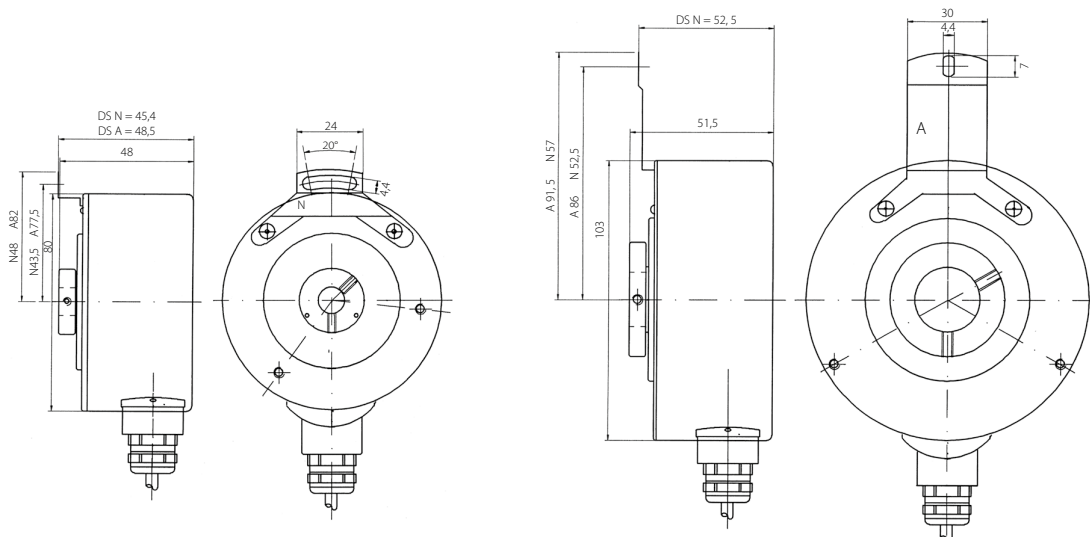

Montagehinweis

Um axialen und radialen Wellenschlag sowie evtl. Winkelsatz ausgleichen zu können, darf der Drehgeberflansch nicht starr befestigt werden. Fixieren Sie den Flansch über eine Statorkupplung (z. B. Federblech) als Verdrehstütze.

Folgende flexible Befestigungsbleche stehen zur Verfügung:

DS A geeignet für Geber Typ HWI 103

Wellenversatz max: +/- 2,0 mm axial, +/- 0,15 mm radial

DS N geeignet für Geber Typ HWI 80

Wellenversatz max: +/- 0,5 mm axial, +/- 0,3 mm radial

Messräder	Typ	Umfang	Material	D	B	Belag	Profil
	M 101	500	Kunststoff oder Aluminium	10 / 12	25	Kunststoff glatt	
	M 102	500	Kunststoff oder Aluminium	10 / 12	25	Kunststoff geriffelt	
	M 120	500	Kunststoff oder Aluminium	10 / 12	25	Noppengummi	
	M 130	500	Kunststoff oder Aluminium	10 / 12	25	Alu-Rändel	
	M 140	500	Kunststoff oder Aluminium	10 / 12	25	Kunststoff Vulkollan	
	M 108	200	Kunststoff oder Aluminium	6/10	12	Kunststoff glatt	
	M 110	200	Kunststoff oder Aluminium	6/10	12	Alu-Rändel	
	M 190	200	Kunststoff oder Aluminium	6/10	12	Noppengummi	
	M 109	200	Kunststoff oder Aluminium	6/10	12	Kunststoff geriffelt	

Mechanische Abmessungen

Messrad 500 mm Umfang

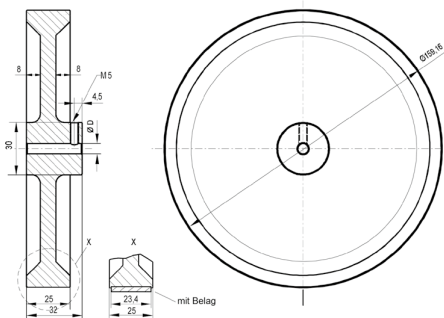



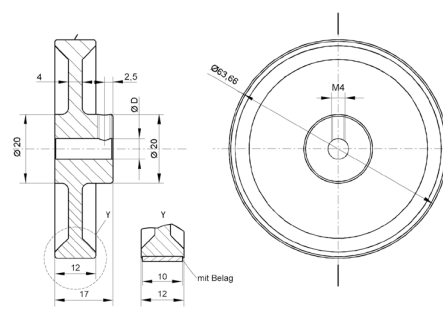



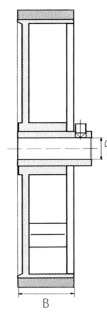

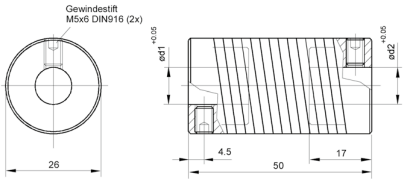
Messrad 200 mm Umfang

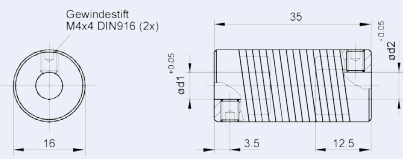

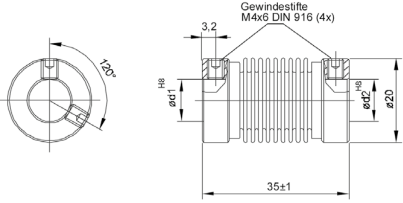
Umfangtoleranz
0,2 % – 0,5 %

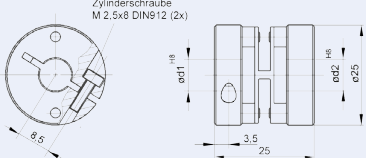

Kupplungen	Typ	A	B	d ¹	d ²	Mechanische Abmessungen
	Federkupplung K 401	50	26	6	6	
				6	8	
				6	10	
				8	8	
				8	10	
				10	10	
				12	12	
	Federkupplung K 402	35	16	4	5	
				5	5	
				5	6	
				6	6	
				6	8	
				6	8	
				8	8	
	Balgkupplung K 409	35	20	4	4	
				4	6	
				6	6	
				6	10	
				8	8	
				10	10	
				10	12	
	Federscheibenkupplung K 410	25	25	6	6	
				6	10	
				8	8	
				10	10	
				10	12	
				10	12	
				12	12	

Zahnstange	Typ	Breite	Höhe	Länge
	Z 214	5	20	1000

Ritzel	Typ	Zähne	Umfang
	R 218	16	50,26

Rundflansch

F 2 für Serie AWI 58, AWI 58H, AWA 58, BC 58, PS und PSM

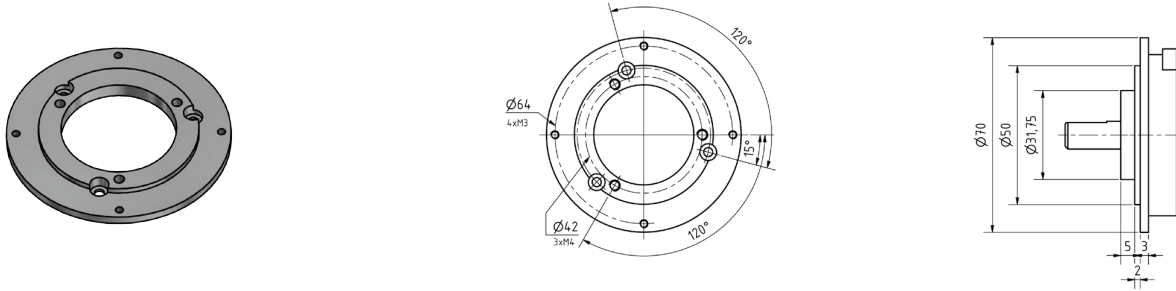

Rundflansch

F 3 für Serie AWI 58, AWI 58H, AWA 58, BC 58, PS und PSM

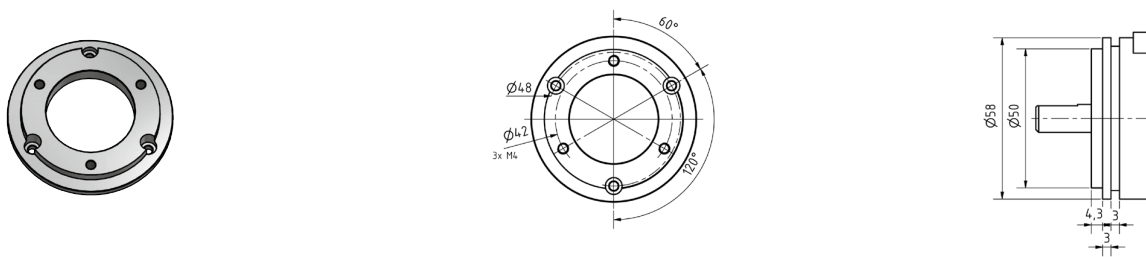

Rundflansch

F 4 für Serie AWI 58, AWI 58H, AWA 58, BC 58, PS und PSM

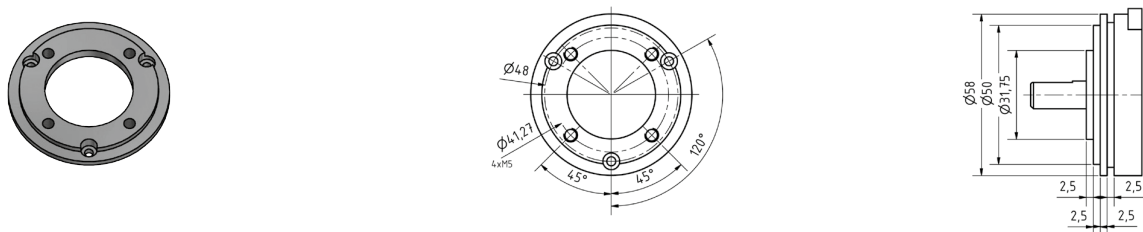

Rundflansch

Euroflansch für Serie AWI 58, AWI 58H, AWA 58, BC 58, PS und PSM, AWI 90, AWA 90, PA 02, PH 05, 70-140 und 72

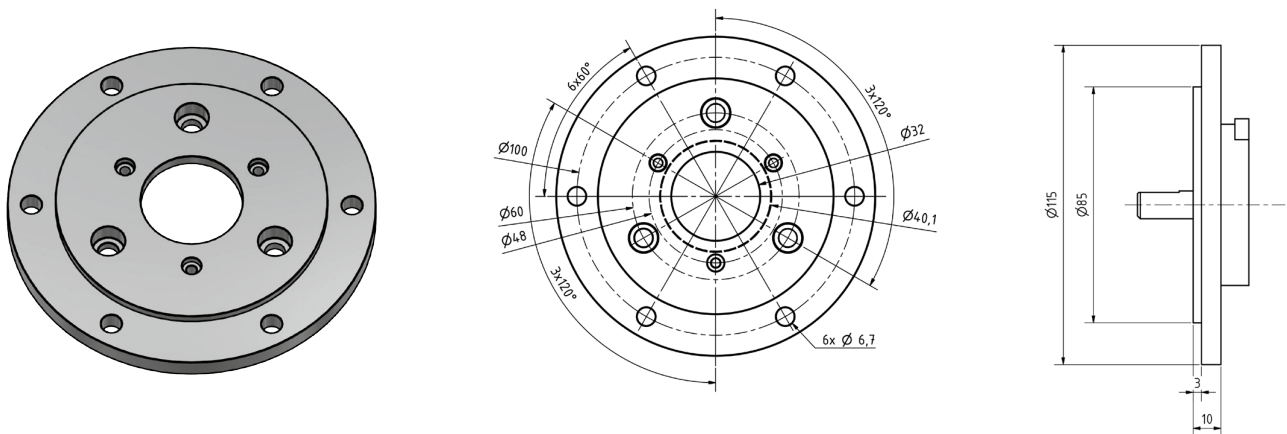

Quadratflansch

F 5 für Serie AWI 58, AWI 58H, AWA 58, BC 58, PS und PSM

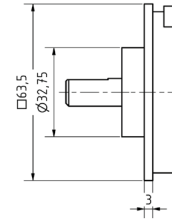
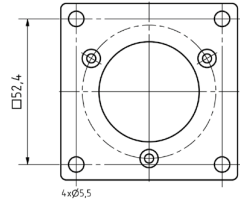
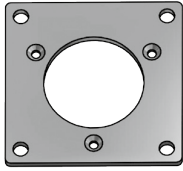

Quadratflansch

F 6 für Serie AWI 58, AWI 58H, AWA 58, BC 58, PS und PSM

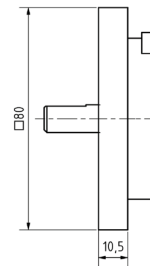
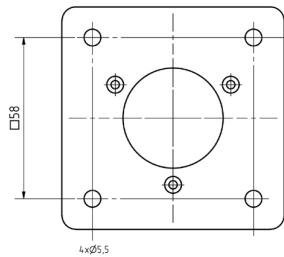
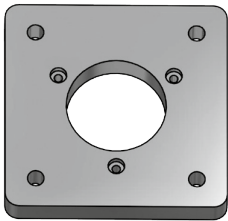

Quadratflansch

F 7 S für Serie AWI 40 S

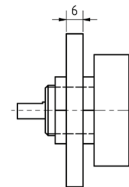
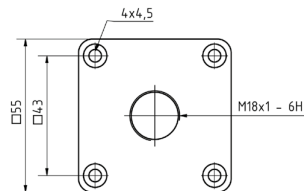
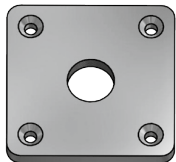

Quadratflansch

F 7 E für Serie AWI 40 E

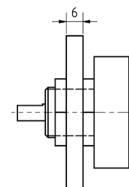
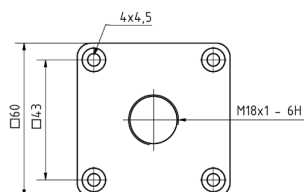

Winkelflansch

WF 1 für Serie AWI 90, AWA 90, PH 05, PA 02, 72, 70-140

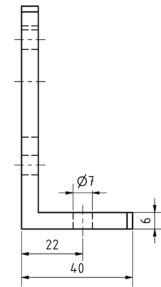
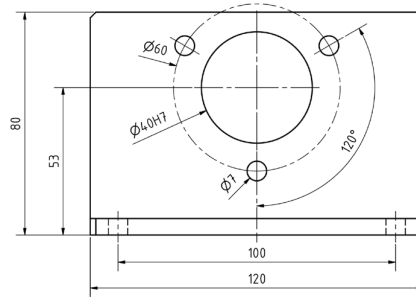
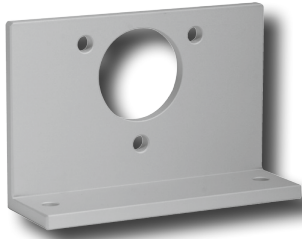

Winkelflansch

WF 2 für Serie AWI 58, AWI 58H, AWA 58, BC 58, PS und PSM

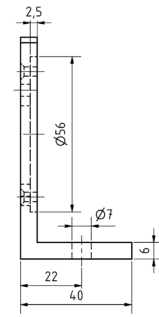
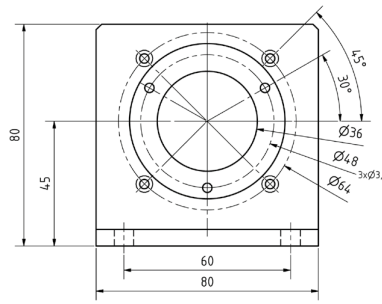
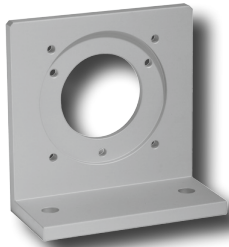

Winkelflansch

WF 3 für Serie AWI 58, AWI 58H, AWA 58, BC 58, PS und PSM

