

FLUKE®

572-2

Infrared Thermometer

Getting Started Manual

PN 4307046

March 2013, Rev. 1, 08/13

©2013 Fluke Corporation. All rights reserved. Specifications are subject to change without notice. All product names are trademarks of their respective companies.

LIMITED WARRANTY AND LIMITATION OF LIABILITY

This Fluke product will be free from defects in material and workmanship for two years from the date of purchase. This warranty does not cover fuses, disposable batteries, or damage from accident, neglect, misuse, alteration, contamination, or abnormal conditions of operation or handling. Resellers are not authorized to extend any other warranty on Fluke's behalf. To obtain service during the warranty period, contact your nearest Fluke authorized service center to obtain return authorization information, then send the product to that Service Center with a description of the problem.

THIS WARRANTY IS YOUR ONLY REMEDY. NO OTHER WARRANTIES, SUCH AS FITNESS FOR A PARTICULAR PURPOSE, ARE EXPRESSED OR IMPLIED. FLUKE IS NOT LIABLE FOR ANY SPECIAL, INDIRECT, INCIDENTAL OR CONSEQUENTIAL DAMAGES OR LOSSES, ARISING FROM ANY CAUSE OR THEORY. Since some states or countries do not allow the exclusion or limitation of an implied warranty or of incidental or consequential damages, this limitation of liability may not apply to you.

Fluke Corporation
P.O. Box 9090
Everett, WA 98206-9090
U.S.A.
11/99

Fluke Europe B.V.
P.O. Box 1186
5602 BD Eindhoven
The Netherlands

Table of Contents

Title	Page
Introduction.....	1
Safety Information	1
Thermometer Use	6
Cable Connections and Battery Replacement..	6
Menu Overview	7
Specifications Summary	9

Introduction

The 572-2 Infrared Thermometer (the Product) is for non-contact temperature measurement. The Product determines the surface temperature of an object by measuring the amount of infrared energy radiated by the object surface. A K-type thermocouple can be used with the Product for contact-temperature measurement.

Safety Information

A **Warning** identifies conditions and procedures that are dangerous to the user. A **Caution** identifies conditions and procedures that can cause damage to the Product or the equipment under test.

Symbols used on the Product and in this manual are explained in Table 1.

Warning

To prevent possible electrical shock, fire, eye damage, and personal injury:

- **Read all safety Information before you use the Product.**
- **Use the Product only as specified, or the protection supplied by the Product can be compromised.**
- **Do not use the Product around explosive gas, vapor, or in damp or wet environments.**
- **Do not use the Product if it operates incorrectly.**

- **See emissivity information for actual temperatures. Reflective objects result in lower than actual temperature measurements. These objects pose a burn hazard.**
- **Do not look directly into the laser with optical tools (for example, binoculars, telescopes, microscopes). Optical tools can focus the laser and be dangerous to the eye.**
- **Do not look into the laser. Do not point laser directly at persons or animals or indirectly off reflective surfaces.**
- **Use the product only as specified, or hazardous laser radiation exposure can occur.**
- **Do not use laser viewing glasses as laser protection glasses. Laser viewing glasses are used only for better visibility of the laser in bright light.**
- **Do not open the Product. The laser beam is dangerous to eyes. Have the Product repaired only through an approved technical site.**
- **Have an approved technician repair the product.**

⚠ Caution

For safe operation and maintenance of the Product:

- **Remove the batteries if the Product is not used for an extended period of time, or if stored in temperatures above 50 °C. If the batteries are not removed, battery leakage can damage the Product.**
- **Replace the batteries when the low battery indicator shows to prevent incorrect measurements.**
- **Repair the Product before use if the batteries leak.**
- **Be sure that the battery polarity is correct to prevent battery leakage.**
- **Do not short the battery terminals together.**
- **Do not keep cells or batteries in a container where the terminals can be shorted.**
- **Do not put battery cells and battery packs near heat or fire. Do not put in sunlight.**

⚠ Caution

To avoid damage to the Product or the equipment under test, protect them from:

- EMF (electro-magnetic fields) from arc welders, induction heaters, etc.
- Static electricity
- Thermal shock (caused by large or abrupt ambient temperature changes. For highest accuracy, allow 30 minutes for Product to stabilize before use).



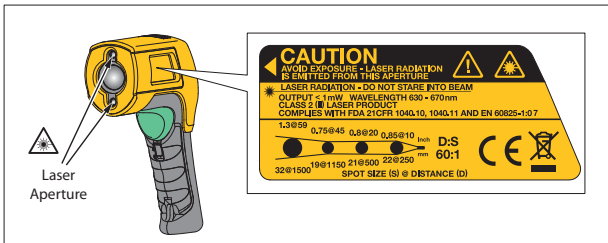





See Figure 1 for the safety markings.



hdp01.eps

Figure 1. Safety Markings

Table 1. Symbols

Symbol	Explanation
	Hazardous voltage. Risk of electrical shock.
	Risk of danger. Important information. See manual.
	Warning. Laser.
CE	Conforms to European Union directives.
°C	Celsius
°F	Fahrenheit
	Battery
	This product complies with the WEEE Directive (2002/96/EC) marking requirements. The affixed label indicates that you must not discard this electrical/electronic product in domestic household waste. Product Category: With reference to the equipment types in the WEEE Directive Annex I, this product is classed as category 9 "Monitoring and Control Instrumentation" product. Do not dispose of this product as unsorted municipal waste. Go to Fluke's website for recycling information.
	Battery
	Conforms to relevant South Korean EMC Standards.
 沪制01120009号	Conforms to China Metrology Certification.

Thermometer Use

To take a temperature reading, point the Product at the desired object and pull the trigger. You can use the laser pointer to aim the Product. You may also insert the K-type thermocouple probe for contact measurement.

⚠⚠ Warning

To avoid electrical shock or personal injury, do not connect the external contact probe to live electrical circuits.

Cable Connections and Battery Replacement

To connect the USB cable and Thermocouple to the Product, and to change the batteries, see Figure 2.

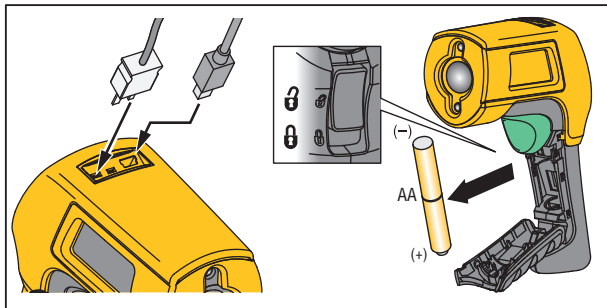

hdv04.eps

Figure 2. Cable Connections and Battery Replacement

Note

To prevent incorrect readings, do not do a temperature measurement of an earthed conductor while the Product is connected to a PC that is earthed by a three-phase grounding plug.

Menu Overview

There are many settings that can be changed by using the menu. Table 2 is a top-level description of the menu. Push the **Menu** button to advance the menu to the next level. Figure 3 shows the LCD and menu interface. The Users Manual explains the menus in full detail.

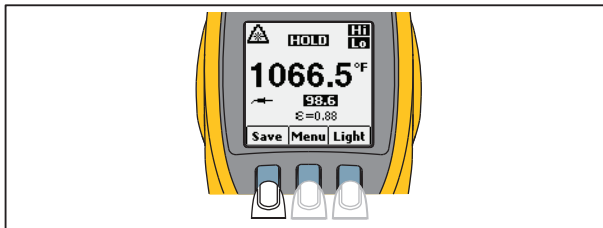

hdp02.eps

Figure 3. Menu Navigation

Table 2. Top-Level Menu Description

Level	Left Softkey	Description	Center Softkey	Right Softkey	Description
1	Save	Save reading to memory	Menu	Light	Adjust bright backlight
2	Mem	Review / delete memories	Menu	ε	Set emissivity
3	MnMx	Enables Min/Max	Menu	Avg	Enable Avg/Diff
4	°F/°C	Toggle between C and F	Menu	Alarm	Set and enable alarms
5	🔒	Lock the Product on	Menu	Laser	Toggle the laser on/off
6	Setup	- Turn off backlight - Change Time/Date - Change Language	Menu		



Specifications Summary

See Users Manual on CD for full specifications.

IR Temperature Range	-30 °C to 900 °C (-22 °F to 1652 °F)
Accuracy	$\geq 0\text{ °C}$: $\pm 1\text{ °C}$ or $\pm 1\%$ of reading, whichever is greater ($\geq 32\text{ °F}$: $\pm 2\text{ °F}$ or $\pm 1\%$ of reading, whichever is greater) $\geq -10\text{ °C}$ to $< 0\text{ °C}$: $\pm 2\text{ °C}$ ($\geq 14\text{ °F}$ to $< 32\text{ °F}$: $\pm 4\text{ °F}$) $< -10\text{ °C}$: $\pm 3\text{ °C}$ ($< 14\text{ °F}$: $\pm 6\text{ °F}$)
K-Type Thermocouple Input Temperature Range	-270 °C to 1372 °C (-454 °F to 2501 °F)
K-Type Thermocouple Input Accuracy	$< -40\text{ °C}$: $\pm(1\text{ °C} + 0.2\text{ °/1 °C})$ $\geq -40\text{ °C}$: $\pm 1\%$ or 1 °C , whichever is greater $< -40\text{ °F}$: $\pm(2\text{ °F} + 0.2\text{ °/1 °F})$ $\geq -40\text{ °F}$: $\pm 1\%$ or 2 °F , whichever is greater

Distance:Spot (90 % energy)	60:1
Laser sighting	Dual laser, output $< 1\text{ mW}$
Emissivity	Digitally adjustable from 0.10 to 1.00 by 0.01 or via built-in table of common materials
Data storage	99 points

Communication	USB 2.0
Operating Altitude	2000 meters
Storage Altitude	12,000 meters
Relative Humidity	10 % to 90 % RH non-condensing up to 30 °C (86 °F)
Operating Temperature	0 °C to 50 °C (32 °F to 122 °F)
Storage Temperature	-20 °C to 60 °C (-4 °F to 140 °F)

Power	2 AA Batteries
Battery Life	8 hours with laser and backlight on; 100 hours with laser and backlight off, at 100 % duty cycle (Thermometer continuously on)
Standards and Agency Approval	EMC: meets IEC61326-1: Portable Safety Compliance: IEC 60825-1, Class 2  <small>沪制01120009号</small> Implement Standard: Q/SXAV 16  
Electromagnetic Compatibility	Applies to use in Korea only. Class A equipment; (Industrial Broadcasting & Communication Equipment) ^[1] [1] This product meets the requirement for industrial (Class A) electromagnetic wave equipment and seller or user should take notice of it. This equipment is intended to use in business environment and is not to be used in homes.